



Jayco[®]
Family of Companies

TOWABLE OWNER'S MANUAL



JAYCO | 903 S. Main Street, Middlebury, IN 46540 | (800) 283-8267

For more information on model features and options, documentation, and the electronic version of this owner's manual, please visit the manufacturer's website or scan the QR code found on the decal just outside the front door of the recreational vehicle.



Hello, I'm Ken Walters, President and CEO of Jayco. I'd like to personally welcome you to the Jayco Family.

The Jayco Family of Companies is comprised of four brands - Jayco, Entegra Coach, Open Range RV and Heartland RV. These divisions have been manufacturing RVs for over 50 years on a tradition anchored in three pillars – Quality, Team and Family. If you are a first-time owner, thank you for choosing us. If you're a second, third or tenth owner, we are beyond pleased to have kept you in the family.

Our mission has remained unchanged since 1968 – design and build with innovation and safety at the forefront of all we do, and continue to be a leading manufacturer for both towable and motorized RVs. From the first pop-up camper built on the Bontrager family farm, to the technology-packed line-up we build today, we always strive for better.

Over the next few years, we hope the memories made in your new RV are ones to remember. Thank you for taking us along for the ride and for letting us be a part of your stories.

Sincerely,

A handwritten signature in black ink, appearing to read 'Ken Walters', followed by a horizontal line.

Ken Walters
President and CEO of Jayco



Training, How-To and Walk Through Videos

Scan the QR Code to access an extensive video training series for owners of Jayco & Highland Ridge brands of RVs, produced in collaboration with the National RV Training Academy (NRVTA). The series provides an in-depth library of videos to provide new and existing owners with training, reference and how-to material for nearly all of the systems and components you will utilize in your RV.



**VIDEO
LIBRARY**



If you have passion for travel, love your RV and have an undeniably unique RV lifestyle, apply to become a Jayco Family of Companies' Pathfinder. As true pioneers and pathfinders of the authentic RV lifestyle, you are in the unique position to offer a genuine depiction of the different segments that come together to build an exclusive RV community. Through you, your stories and the compelling content you create, you'll elevate our brands while strengthening your own, increasing followers, inspiring RVers and establishing yourself as leaders and experts in the RV world.

GET SOCIAL WITH US!



PATHFINDER
COMMUNITY



NEW OWNER
FORM

Change of Ownership Notification

Should you be the new owner of a used RV, or be the responsible party selling your RV to a new owner, please scan this QR code and fill out the Change of Ownership Form. Federal record keeping laws require that we maintain a file of owners of our product. Your cooperation in filling out this form will be appreciated.

ABOUT THIS MANUAL

Welcome to your recreational vehicle (RV) owner's manual! This guide is designed to help you operate the features, equipment, and controls of your RV effectively. If you notice any significant variations in components from what is described here, please reach out to your dealer to ensure you have the correct information.

Please note that this manual does not create any warranty, expressed or implied, and may not cover every detail of the equipment, standard, or optional, installed on or in your RV.

The information, illustrations, and specifications provided here are based on the most current available data at the time of publication approval. However, they are subject to change and may not accurately represent actual sizes.

This Owner's Manual, Warranty Guide, and Customer Information Packet are permanent components of your RV. Please keep them stored in your RV at all times for personal reference. If you decide to sell your RV, these documents should remain with it for the next owner's reference.

CUSTOMER INFORMATION PACKET

Please note that certain components of your RV may not be covered under the RV warranty or may be warranted separately by their individual manufacturers. The Customer Information Packet includes the RV Warranty Guide along with manuals, information sheets, warranty cards, and registrations provided by component manufacturers.

For any questions regarding operation, maintenance, servicing instructions, or warranty coverage, please refer to these documents. It is crucial to complete and mail warranty cards and registrations within the specified time limits to ensure you maintain warranty coverage and avoid any potential loss of warranty benefits.

WARNINGS AND OTHER LABELS

Informational labels will be attached at various locations on the interior and exterior of your RV. These labels are there for your guidance and protection, and should never be tampered with or removed.

NOTICE TO CALIFORNIA CUSTOMERS ONLY: Jayco, Inc. has elected to follow the procedures described in Cal. Civ. Proc. Code § 871.20 et seq., regarding pre-litigation notice requirements for consumer claims brought pursuant to the Song Beverly Consumer Warranty Act.

SAFETY ALERTS

Look for labels like NOTE, CAUTION, WARNING, and DANGER throughout this manual. They highlight precautions and potential risks that, if ignored, could cause personal injury, property damage, or harm to your RV.

These instructions are essential for your safety and are also provided in the Warranty Packet and on safety labels on your RV. Always follow them carefully.

Wear appropriate safety gear when servicing your RV. If unsure, contact your dealer or our customer service representatives for guidance.

WINGMATE™ HELP

Look for the Jayco WINGMATE™ icon throughout this manual. It indicates that useful information can be found in the free Jayco WINGMATE™ mobile application.



The Jayco WINGMATE™ app is a user-friendly tool designed for Jayco owners and anyone camping in an RV. It offers a range of features including quick-start videos, maintenance checklists, how-to tutorials, trip and packing checklists, campsite considerations, Jayco RV Owner's Manuals, an extensive glossary of RV terms, and more.

Download the Jayco WINGMATE™ app for free from the Apple App Store or Google Play Store to access these valuable resources.

QR CODES

Watch for QR codes throughout this manual. Scanning these codes will directly link you to specific information and videos relevant to the section you're reading.

JAYCO UNIVERSITY

Explore Jayco University, a resource developed by the National RV Training Academy, offering FREE video courses to help you understand your RV better. These courses cover various aspects of your RV, including how its systems work and common troubleshooting advice.



Look for the University logo throughout this manual to find sections with relevant course content.

Visit online.rvtechcourse.com/courses/jayco-university to access Jayco University and enhance your RV knowledge.



This is the safety alert symbol. It is used to alert you to potential personal injury hazards. Obey all safety messages that follow this symbol to avoid possible injury or death.

NOTICE TO QUEBEC RESIDENTS UNDER THE QUEBEC CONSUMER PROTECTION ACT – NO GUARANTEE OF AVAILABILITY OF REPLACEMENT PARTS AND REPAIR SERVICES

Most RVs are covered by a 2-year Limited Warranty. Please see our full warranty terms and conditions here, which also include a list of the RVs and their components covered by that Limited Warranty: www.jayco.com

Beyond the terms of the Limited Warranty, Jayco does not warrant or guarantee the availability of, and hereby explicitly disclaims any implied, statutory or other warranty or guarantee of availability of, any spare or replacement parts, repair services or information necessary for the maintenance or repair of RVs, their components or any other product offered for sale by Jayco.

NOTICE TO QUEBEC RESIDENTS UNDER THE QUEBEC CONSUMER PROTECTION ACT – NO GUARANTEE OF AVAILABILITY OF REPLACEMENT PARTS AND REPAIR SERVICES

Most RVs are covered by a 1-year Limited Warranty. Please see our full warranty terms and conditions here, which also include a list of the RVs and their components covered by that Limited Warranty: www.drvsuites.com.

Beyond the terms of the Limited Warranty, DRV does not warrant or guarantee the availability of, and hereby explicitly disclaims any implied, statutory or other warranty or guarantee of availability of, any spare or replacement parts, repair services or information necessary for the maintenance or repair of RVs, their components or any other product offered for sale by DRV.

NOTICE TO QUEBEC RESIDENTS UNDER THE QUEBEC CONSUMER PROTECTION ACT – NO GUARANTEE OF AVAILABILITY OF REPLACEMENT PARTS AND REPAIR SERVICES

Most RVs are covered by a 1-year Limited Warranty. Please see our full warranty terms and conditions here, which also include a list of the RVs and their components covered by that Limited Warranty: openrangerv.com.

Beyond the terms of the Limited Warranty, Open Range does not warrant or guarantee the availability of, and hereby explicitly disclaims any implied, statutory or other warranty or guarantee of availability of, any spare or replacement parts, repair services or information necessary for the maintenance or repair of RVs, their components or any other product offered for sale by Open Range.



NOTICE TO QUEBEC RESIDENTS UNDER THE QUEBEC CONSUMER PROTECTION ACT – NO GUARANTEE OF AVAILABILITY OF REPLACEMENT PARTS AND REPAIR SERVICES



Most RVs are covered by a 1-year Limited Warranty. Please see our full warranty terms and conditions here, which also include a list of the RVs and their components covered by that Limited Warranty: <https://heartlandrvs.com/>

Beyond the terms of the Limited Warranty, Heartland does not warrant or guarantee the availability of, and hereby explicitly disclaims any implied, statutory or other warranty or guarantee of availability of, any spare or replacement parts, repair services or information necessary for the maintenance or repair of RVs, their components or any other product offered for sale by Heartland.

NOTE

Gives helpful information.

 **NOTICE** 
Indicates a potential situation that, if not avoided, may result in property damage or damage to your RV.

 **CAUTION** 
Indicates a potentially hazardous situation that, if not avoided, may result in minor or moderate injury. It may also be used to alert against unsafe practices.

 **WARNING** 
Indicates a potentially hazardous situation that, if not avoided, may result in death or serious injury.

 **DANGER** 
Indicates an imminently hazardous situation that, if not avoided, will result in death or serious injury. This alert information is limited to the most extreme situations.

TABLE OF CONTENTS

SECTION 1: INTRODUCTION

SECTION 2: OCCUPANT SAFETY

SECTION 3: PRE TRAVEL INFORMATION

SECTION 4: VEHICLE OPERATION

SECTION 5: SLIDEOUT SYSTEMS

SECTION 6: ELECTRICAL

SECTION 7: FUEL & PROPANE SYSTEM

SECTION 8: PLUMBING SYSTEM

SECTION 9: HEATING & COOLING

SECTION 10: APPLIANCES

SECTION 11: ELECTRONICS

SECTION 12: INTERIOR

SECTION 13: EXTERIOR

SECTION 14: CHECKLISTS

SECTION 15: ADDITIONAL INFORMATION



TABLE OF CONTENTS

SECTION 1: INTRODUCTION

ASCEND COMMUNITY	3
ABOUT THIS MANUAL	4
CUSTOMER INFORMATION PACKET	4
WINGMATE™ HELP.....	4
QR CODES	4
WARNINGS AND OTHER LABELS	4
SAFETY ALERTS	4

SECTION 2: OCCUPANT SAFETY

SECONDARY MEANS OF ESCAPE (EXIT WINDOW)	10
FIRE SAFETY	10
FIRE EXTINGUISHER	10
SMOKE ALARM	10
FORMALDEHYDE.....	10
COMBINATION CARBON MONOXIDE /PROPANE ALARM	11
CONDENSATION.....	11
EXTENDED OR FULL TIME USAGE.....	11
COLD WEATHER USAGE	11

SECTION 3: PRE TRAVEL INFORMATION

TOW VEHICLE	13
VEHICLE LABELS.....	13
REAR BUMPER	14
LOADING YOUR RV	14
TRAVEL TRAILER HITCH (CUSTOMER SUPPLIED)	15
FIFTH WHEEL PIN BOX (CUSTOMER SUPPLIED)	16
WEIGHING YOUR TOW VEHICLE AND RV.....	17
WIRE HARNESS/CONNECTOR PLUG.....	17

SECTION 4: VEHICLE OPERATION

TOWING.....	19
TOWING BEHIND YOUR RV	20
ENTRANCE DOOR STEP(S)	20
STEP LIGHT.....	20
STOWABLE ENTRANCE DOOR STEP.....	20
ENTRANCE DOOR.....	21
LEVELING SYSTEM (IF EQUIPPED).....	22
STABILIZERS.....	22
TANDEM AXLE FLEX EQUALIZER (IF EQUIPPED)	23
EMERGENCY STOPPING.....	24
EMERGENCY TOWING.....	24
WHEEL LUGS	24
TIRES	25

TIRE PRESSURE MONITOR SYSTEM (TPMS) (IF EQUIPPED)	25
CHANGING A TIRE	26
SPARE TIRE CARRIER (IF EQUIPPED)	26
SETTING UP YOUR RECREATION VEHICLE	27
CAMPSITE HOOK-UP	27
SEASONAL SET-UP (BUNGALOWS ONLY)	28
CARGO RAMP DOOR	30
LOADING THE CARGO AREA.....	31
PATIO DECK - REAR (IF EQUIPPED).....	31
PATIO DECK - SIDE (IF EQUIPPED).....	32
AWNINGS (IF EQUIPPED)	33

SECTION 5: SLIDEOUT SYSTEMS

ELECTRIC SLIDE ROOM(S) (IF EQUIPPED)	37
SLIDE TYPES	37

SECTION 6: ELECTRICAL

THE ELECTRICAL SYSTEM.....	40
12-VOLT DC SYSTEM	40
LOAD CENTER.....	41
EXTERIOR LIGHTS (IF EQUIPPED)	41
REPLACING LIGHTING.....	41
COMMAND CENTER.....	42
GFCI RECEPTACLE	42
JAYCOMMAND PLUS BMPRO SYSTEM (IF EQUIPPED)	43
120-VOLT AC ELECTRIC SYSTEM.....	44
120-VOLT 30-AMP AC ELECTRIC SYSTEM (IF EQUIPPED).....	45
120-VOLT 50 AMP AC ELECTRIC SYSTEM (IF EQUIPPED)	45
TESTING CAMPSITE POWER CONNECTION.....	45
CONNECTING POWER CORD(S)	45
POWERED CORD REEL (IF EQUIPPED)	46
INVERTER (IF EQUIPPED)	46
POWER CONVERTER	46
120-VOLT CIRCUIT BREAKERS	47
APPROXIMATE ELECTRICAL LOAD RATINGS	48
AUXILIARY BATTERY (CUSTOMER SUPPLIED)	49
GENERATOR (IF EQUIPPED).....	50
SOLAR PREP (IF EQUIPPED)	51
SOLAR PACKAGE (IF EQUIPPED).....	52

SECTION 7: FUEL & PROPANE SYSTEM

EXHAUST GAS FUMES	55
PROPANE GAS SYSTEM.....	55
PROPANE USE AND SAFETY	56

TABLE OF CONTENTS

USING THE FUEL STATION (IF EQUIPPED - SEISMIC ONLY) 57

SECTION 8: PLUMBING SYSTEM

PLUMBING SYSTEM 60

MONITOR PANEL 60

FRESH WATER SYSTEM 61

FRESH WATER CONNECTIONS 62

WATER PURIFICATION SYSTEM (IF EQUIPPED) 62

SPRAY PORT (IF EQUIPPED) 63

TOILET 63

DRAINING THE FRESH WATER SYSTEM 64

UTILITY CENTERS 65

WATER HEATER 67

FAUCETS 68

ON DEMAND WATER HEATER (IF EQUIPPED) 68

DRAINING AND WINTERIZATION 68

BATHROOM TUB / SHOWER 69

OUTSIDE SHOWER (IF EQUIPPED) 69

BLACK/GREY WATER SYSTEM AND TANKS 69

BLACK AND GREY TANK DRAINS 71

MACERATOR PUMP SYSTEM (IF EQUIPPED) 72

BLACK TANK FLUSH (IF EQUIPPED) 73

TANK HEATERS (IF EQUIPPED) 73

SANITIZING/WINTERIZING THE PLUMBING SYSTEM 74

SECTION 9: HEATING & COOLING

AIR CONDITIONER 79

POWER ROOF VENT (IF EQUIPPED) 79

FIREPLACE (IF EQUIPPED) 79

CEILING FAN (IF EQUIPPED) 80

FURNACE 80

SECTION 10: APPLIANCES

MICROWAVE 81

COOKTOPS, RANGE AND OVEN (IF EQUIPPED) 81

COOKING SAFETY 82

REFRIGERATOR 82

RANGE HOOD (IF EQUIPPED) 82

JAYPORT™ AND GAS BBQ GRILL 83

PROPANE GRILL QUICK COUPLER 83

OUTSIDE KITCHEN (IF EQUIPPED) 83

TAILGATER CAMP KITCHEN (IF EQUIPPED - SEISMIC) 83

WASHER/DRYER PREP (IF EQUIPPED) 84

CENTRAL VACUUM SYSTEM (IF EQUIPPED) 85

SECTION 11: ELECTRONICS

WINEGARD® AIR™ 360 ANTENNA 88

WINEGARD® GATEWAY ROUTER (IF EQUIPPED) 88

CAMERA PREP/CAMERA (IF EQUIPPED) 89

EXTERIOR SLIDING / PIVOTING TV (IF EQUIPPED) 89

SECTION 12: INTERIOR

CLEANING THE INTERIOR 91

SOFAS AND DINETTES 91

TOKYO BED (IF EQUIPPED) 93

POWER BUNK BED (SEISMIC CARGO BAY) 93

MURPHY BED (IF EQUIPPED) 95

STANDARD BED STORAGE 95

BUNK BED AND LOFT LADDERS (IF EQUIPPED) 96

BED RAILS 96

SECTION 13: EXTERIOR

CLEANING THE EXTERIOR 98

CLEANING SLIDE-OUT SEALS 99

E-Z LUBE® OR SUPER LUBE™ AXLE (IF EQUIPPED) 100

EXTERIOR ROOF AND SIDEWALL VENTS 100

WINDOWS 100

EXTERIOR LADDER (IF EQUIPPED) 100

SEALANTS 101

SECTION 14: CHECKLISTS

TRAVEL CHECKLIST 103

RV STORAGE CHECKLIST 104

SECTION 15: ADDITIONAL INFORMATION

FEATURED COMPONENTS QUICK REFERENCE CHART 105

HELPFUL LINKS 106



SECTION 2: OCCUPANT SAFETY



SECONDARY MEANS OF ESCAPE (EXIT WINDOW)

CAUTION (See page 12)

Your RV has a window(s) as a secondary exit. Identified by red latches and a label, it allows quick escape if the main door is inaccessible.

Keep the EXIT label(s) intact.

Ensure the exit window isn't obstructed when parked. Check the ground below for a safe escape route.

Practice opening the window before emergencies, and ensure all occupants know how.

Your RV may be equipped with one of the following exit window styles:

Flip Latch Style (2 Per Window)

1. Push up on the front lip of the latch to unfold it.
2. Push up on the front lip again to unhook the latch from the window.
3. Once both latches are released, push out on the window, hinged at the top, to exit the RV.
4. The screen does not need to be removed.



Slider Window Latch Style

1. Pull the lever down to unlock the window.
2. Slide the window to the right to open and exit the RV.
3. The screen does not need to be removed.



Lever Style Latch

1. Remove the screen by pulling the red tab (upper right arrow).
2. Pull the lever out from the sash clamps.
3. Swing the lever out so it is positioned straight out from the window.
4. Push the lever (and window) out to open.
5. Exit the RV.



FIRE SAFETY

DANGER (See page 12)

If a fire does start, follow these basic safety rules:

1. Evacuate everyone from the RV immediately and call 911.
2. Make sure everyone is accounted for.
3. Get clear of the RV and allow the fire department to handle the emergency.

FIRE EXTINGUISHER

WARNING **DANGER** (See page 10 & page 10)

A dry chemical fire extinguisher is installed near the entrance door. It's designed for tackling small fires of Class B or C type (flammable liquids and electrical).

We recommend familiarizing yourself with the operating instructions displayed on the side of the fire extinguisher

For detailed guidance on fire extinguisher use, consult the user's manual included in your customer information packet.

SMOKE ALARM

WARNING (See page 12)

For your safety, a smoke alarm is installed in every RV. Most detectors are powered by a 9-volt battery, which should be inspected and replaced as necessary. Ensure the smoke alarm remains free of dust.

For detailed instructions on safety, testing, troubleshooting, maintenance, and smoke alarm expiration and replacement, refer to the manufacturer's user guide in your customer information packet.

FORMALDEHYDE

Certain components in the RV contain formaldehyde-based adhesives, which may emit formaldehyde fumes into the air for an undetermined duration. Individuals allergic to formaldehyde gas fumes may experience irritation to the eyes, ears, nose, and throat. Prolonged closure of the RV may also impact indoor air quality.

To assist in dissipating formaldehyde fumes:

- Ventilate the RV by opening all windows.
- Use a fan to circulate air within the RV.



COMBINATION CARBON MONOXIDE /PROPANE ALARM

⚠ DANGER ⚠ **⚠ WARNING ⚠** (See page 12)

Your RV is equipped with a combination carbon monoxide (CO) / propane alarm specifically designed for RV use. This alarm is wired directly to the 12-volt electrical system, powered continuously by the RV batteries. If the battery cable is disconnected, the alarm will not function.



Carbon monoxide/ Propane alarm (alarm may vary)

It's essential to read, understand, and adhere to the owner's information provided by the manufacturer of the combination CO/ propane alarm. This includes details regarding the limited life of the alarm.

Carbon monoxide (CO) is a silent and deadly gas. It's odorless, colorless, and tasteless, making it difficult to detect. Symptoms of CO poisoning should be discussed with all household members:

- Mild exposure: Slight headache, nausea, vomiting, fatigue (similar to flu-like symptoms).
- Medium exposure: Severe headaches, drowsiness, confusion, rapid heart rate.
- Extreme exposure: Unconsciousness, convulsions, cardiac and respiratory failure, death.

Your combination carbon monoxide/propane alarm is designed to detect toxic fumes resulting from incomplete combustion, such as those from appliances, furnaces, fireplaces, and auto exhaust.

Maintenance

- Vacuum the alarm cover annually. Clean it by hand using a damp cloth and dry with a soft cloth. Avoid spraying cleaning agents or waxes on the alarm's front panel, as this may damage the sensor.
- Do not paint the face of the alarm.
- Refer to the manufacturer's user manual for additional information on functions and alarm testing.
- Test the alarm after storage, before each trip, and at least once per week during use.

- Repair or replace the alarm if it malfunctions.

The manufacturer recommends replacing the detector five years after the purchase date for optimal safety.

CONDENSATION

⚠ WARNING ⚠ (See page 12)

Condensation is natural and varies with climate, especially humidity levels. It occurs when air's water vapor reaches the "dew point" and turns into liquid.

To control condensation:

- Ventilate by cracking windows and roof vents.
- Open bath roof vent (if equipped) during showers.
- Use range hood fan (if equipped) while cooking or washing dishes.
- Avoid drying wet towels or clothes inside.
- Open cabinet or closet doors slightly for ventilation if condensation is present.

EXTENDED OR FULL TIME USAGE

⚠ CAUTION ⚠ (See page 12)

Unless labeled for full-time use, your RV isn't designed for continuous living or permanent residence. Doing so may lead to accelerated wear and damage to its components.

COLD WEATHER USAGE

When operating in freezing temperatures:

- **Fresh Water and Drainage Systems:** Take precautions to prevent freeze-ups.
- **Propane Gas:** Ensure sufficient power for the propane gas regulator to prevent freeze-ups. Note that increased furnace operation will raise battery draw and propane gas consumption.
- **Condensation Control:** Ventilate or use a dehumidifier during cool weather to reduce condensation.
- **Extrusions Check:** Before operation, inspect outside extrusions (compartment doors, locks, slide outs, windows, vents, etc.) for frozen moisture to prevent damage.

**FIRE SAFETY (See page 10)**

Avoid using water to extinguish the fire as it can spread certain types of fires and pose a risk of electrocution in the case of an electrical fire.

FIRE EXTINGUISHER (See page 10)

After using a fire extinguisher, refrain from restoring electrical power or plugging in appliances. For detailed maintenance and clean-up instructions, consult the fire extinguisher's user manual.

CARBON MONOXIDE /PROPANE ALARM (See page 11)

If the alarm is triggered, exit the vehicle immediately and seek assistance. Although gases may dissipate, it's crucial to locate and repair the source of the leak.

Your combination carbon monoxide/propane alarm detects toxic carbon monoxide fumes from incomplete combustion and propane leaks. Refer to the user's guide for instructions and audible/visual warning details.

**FIRE EXTINGUISHER (See page 10)**

Avoid checking pressure, testing, or practicing with the fire extinguisher by squeezing the trigger, even briefly. It's non-rechargeable and non-refillable. Once used, it gradually loses pressure and may not be fully charged for an emergency.

SMOKE ALARM (See page 10)

This smoke alarm does not notify hearing-impaired residents. For the hearing-impaired, we recommend special alarms with flashing strobe lights.

Only use the replacement battery recommended by the smoke detector manufacturer. Other batteries may cause the alarm to malfunction. Avoid using rechargeable batteries as they may not provide a constant charge. Never disconnect the battery to silence the alarm.

Test the smoke alarm after storage, before each trip, and at least once per week during use. Do not disconnect the battery or the alarm.

CARBON MONOXIDE /PROPANE ALARM (See page 11)

- Do not obstruct the alarm, allowing gas to enter.
- The alarm detects carbon monoxide, not smoke, fire, or other gases.
- It's intended for typical indoor RV locations, not OSHA standards.
- Consider audible and visual warning devices for CO concentrations under 30 PPM for those with medical issues.
- The alarm only detects CO gas near the sensor, and it's your responsibility to ensure safety.
- Don't disconnect the battery or alarm.
- Avoid silencing the alarm by turning off the battery disconnect or disconnecting the cable. Wait for CO levels to drop.
- Stay outside until the alarm is silenced; its loudness (85db) is designed for emergency alerting but may be harmful if close for too long.

CONDENSATION (See page 11)

Condensation can lead to dampness, mildew, mold, staining, and potential damage to the recreational vehicle (not covered by warranty). It may also pose health hazards due to mold or mildew issues.

**SECONDARY MEANS OF ESCAPE - EXIT WINDOW (See page 10)**

Exercise care when opening the exit window. If opened too far, it may come off the hinge. This may result in damage to the unit or window.

EXTENDED OR FULL TIME USAGE (See page 11)

Continuous or permanent living in your RV may affect your warranty coverage and could void the "Limited Warranty" applicable to your vehicle.

SECTION 3: PRE TRAVEL INFORMATION



TOW VEHICLE

Before towing your RV with a vehicle you own or plan to purchase, ensure that the Gross Vehicle Weight Rating (GVWR) of your RV does not exceed the towing rating of your tow vehicle. Consult your automotive dealer for guidance on obtaining information regarding towing considerations, including whether your vehicle has an optional tow package.

VEHICLE LABELS

⚠ WARNING ⚠ (See page 18)

Decals and data plates used throughout the RV aid in safe and efficient operation; others give service instructions. Read all decals, data and instruction plates before operating your RV. Any decal, data or instruction plate painted over, damaged or removed should be replaced.

In case of theft or vandalism, keep a record of the 17-digit chassis vehicle identification number (VIN), the 8-digit serial number, and your license number. This information may be required by authorities for identification purposes.

WEIGHT TERMS

GAWR - Gross Axle Weight Rating

- Maximum load capacity of a single axle system

GCWR - Gross Combined Weight Rating

- Maximum loaded weight of trailer with full propane, water, and fuel.

GVWR - Gross Vehicle Weight Rating

- Maximum allowable weight of fully loaded trailer.

OCCC - Occupant And Cargo Carrying Capacity

- Trailer's weight capacity after deducting factory weight, personal cargo, propane, and water.

Additions to or changes made after leaving the factory may reduce the OCCC.

UVW - Unloaded Vehicle Weight

- Weight of trailer at factory with full propane.



WEIGHT AND CAPACITY LABELS

The following labels are typically located on the roadside front corner of the RV. An additional Cargo Carrying Capacity label may also be located on or near the entry door.

CCC Label (Cargo Carrying Capacity):

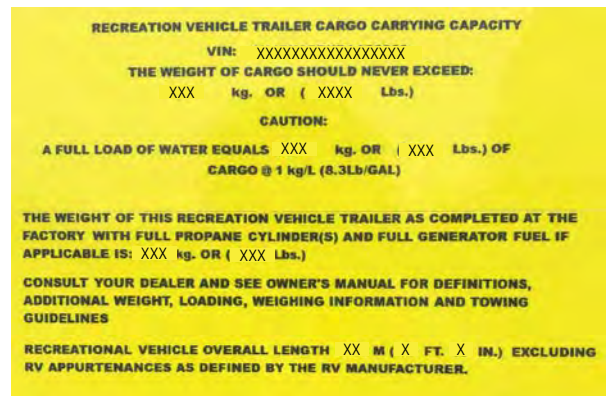

CCC Label Example

The top section of this yellow label is a federal requirement and indicates the maximum Cargo Carrying Capacity allowed for the trailer as it left the factory after being weighed. This maximum capacity does not include the weight of a full fresh water tank.

NOTE

Labels for the Canadian market are white and weight measurements include the weight of a full water heater and fresh water tank.

Modifications or additions made to the trailer post-factory will impact (reduce) the CCC. The middle section of this label, provided voluntarily, displays the trailer's weight as manufactured and weighed at the factory, inclusive of full propane tanks and generator fuel (if applicable).

For instance, if each tire is rated at 2,000 lbs. and there are four tires (totaling 8,000 lbs.), and the RV has a GVWR of 9,000 lbs. with a tongue weight of 1,200 lbs., the actual weight on the RV tires would be (9,000 - 1,200) = 7,800 lbs., which falls within the tire weight rating.

PRE TRAVEL INFORMATION

The Federal Certification Label

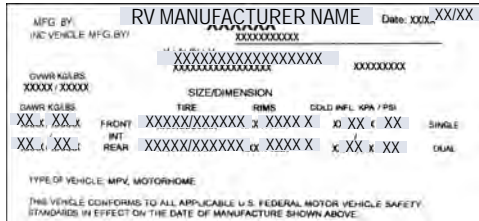

Federal Certification Label Example

The Federal Certification Label, mandated by government regulations, confirms the trailer's compliance with all motor vehicle standards for both Canada and the United States. It contains crucial details such as the manufacturer's name, VIN, GVWR, GAWR (front/rear), tire and rim sizes, and cold tire inflation pressures.

Tire and Loading Label

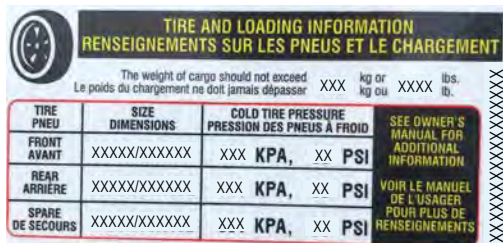

Tire and Loading Label Example

Tire and Loading Label provides information on the tire sizes, cold tire inflation pressures, the VIN and maximum cargo capacity. The maximum cargo capacity listed on the label does not include the weight of a full load of water.

If you have further questions, please contact your dealer or our Customer Service department.

REAR BUMPER

CAUTION (See page 18)

The rear bumper of your RV is not designed to carry cargo. Items that extend beyond the bumper or weigh over 100 lbs. (45kg) will place undo strain on the bumper. The 100 lb. bumper capacity includes the weight of the spare tire (if equipped).

NOTE

Some items, like bike racks, may fall within weight limits but can still cause damage. Excess weight behind the axle may reduce hitch weight, affecting handling.

CARGO CARRYING ACCESSORY RECEIVER (IF EQUIPPED)



The receiver is designed solely for cargo carrying accessories. DO NOT tow trailers or other vehicles. The load limit for this receiver is 300 lbs. Exceeding this limit or using it for towing will void the warranty. Failure to adhere to these instructions could lead to the carrier collapsing or items falling, resulting in accidents causing death or serious injury.

LOADING YOUR RV

WARNING DANGER (See page 18)

Before traveling, ensure all loose items inside the RV are stored and secured. Distribute cargo evenly side-to-side to avoid exceeding one-half of the GAWR for each axle. Secure tie-down straps on appliances or furniture if equipped. Additionally, load heavy objects on the floor or as low as possible for stability.

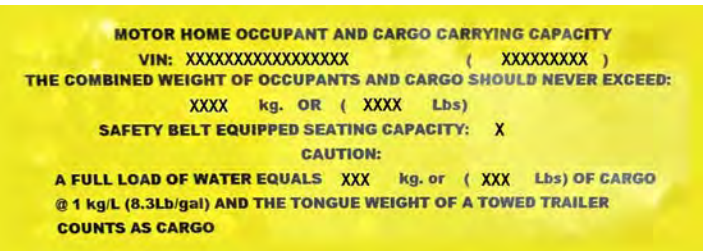

TRAVEL TRAILER HITCH (CUSTOMER SUPPLIED)

⚠ CAUTION ⚠ (See page 18)

The hitch you choose significantly impacts the towing and handling of your RV. Ensure you have the correct hitch installed for safe towing.

Consult your dealer for guidance on the appropriate class and type of hitch for your specific tow vehicle/RV combination. A travel trailer requires a frame-mounted hitch.

The hitch class rating is determined by its towing capacity and weight classification. Before selecting a hitch, know your GVWR and tongue weight. The hitch package rating should match or exceed your RV's GVWR and hitch weight.

Some vehicle suspension systems can exacerbate swaying when towing an RV. Ensure your dealer is informed about your tow vehicle to achieve a compatible hookup.

Travel Trailer Hitch Weight

Maintain the correct tongue weight of the trailer, which should fall within the target range of 10% to 15% of the overall gross weight (travel trailer weight plus contents).

Travel Trailer Hitch Height And Hitch Ball

To determine the hitch height for your model, ensure the trailer is level. When hitched to the tow vehicle, measure the distance from the center of the hitch ball to the ground. Record this number for future reference.

Hitch height is:

Adjust the hitch assembly to achieve a level position for both the tow vehicle and the trailer. A high hitch can cause fishtailing, while a low hitch may transfer excessive weight. Follow the hitch manufacturer's instructions for proper adjustment.

For further assistance, consult your dealer, ensuring they are aware of your tow vehicle for compatibility. The required travel trailer hitch ball diameter is either 2" or 2-5/16", depending on the model.

Travel Trailer Hitching Procedure

The following procedure will help to assist you in securely hooking up your RV to your tow vehicle.



1. Chock the trailer wheels.
2. Turn the tongue jack crank (or press EXTEND/UP on electric jacks) to raise the travel trailer tongue above the hitch ball.
3. Open the coupler latch on the travel trailer hitch.
4. Back the tow vehicle into the proper position.
5. Turn the tongue jack crank (or press RETRACT/DOWN on electric jacks) to lower the coupler onto the hitch ball.
6. Close the coupler latch after it is completely seated.
7. Install the (customer supplied) weight distributing bars (equalizers) as directed by the OEM (if equipped).
8. Remove any dolly wheel or platform and retract the tongue jack to its maximum height off of the ground.
9. Attach the breakaway switch cable to the tow vehicle.
10. Attach the safety chains (See "Travel Trailer Safety Chains" on page 16).

11. Plug in your wire harness/connector plug from the tow vehicle to the travel trailer.
12. Walk around the RV to verify exterior lights are working correctly.
13. Remove the trailer wheel chocks.

NOTE

If using a brake actuator, refer to the manufacturer's owner's manual for detailed and important hitching and safety information.

Travel Trailer Weight Distributing System (customer supplied)

This system enhances stability for your tow vehicle and RV combination by evenly distributing weight to the vehicle's front and rear axles as well as the trailer axle. Consult your dealer for requirements and operation details of this system. Ensure your tow vehicle can support the hitch weight.

Travel Trailer Sway Control (customer supplied)

Sway control devices are available to minimize sway caused by various factors like crosswinds, passing vehicles, improper weight distribution, or excessive speed. Install a sway control device to manage side-to-side movement and prevent sway. Contact your dealer for more information.

Suggestions for sway situations:

- Gradually release the accelerator.
- Minimize steering adjustments to avoid exacerbating sway.
- Stop safely to identify the cause of the sway and check equipment and load distribution. If the issue persists, contact your dealer for assistance and reduce speed until resolved.



Sway Control/ Weight Distribution Hitch Example



PRE TRAVEL INFORMATION

Travel Trailer Safety Chains

Your RV comes with safety chains meeting SAE standards for maximum gross trailer weight. Ensure these chains are always attached when towing. Follow the steps below to install them properly:

1. Cross the left safety chain under the coupler and attach it to the right mounting slot in the trailer hitch.
2. Repeat this process with the right safety chain.
3. Ensure each chain has equal slack, only enough to allow the vehicle to turn at its minimum radius without dragging on the ground.

NOTE

Do not connect the emergency brake line of your RV to the safety chain or safety chain hook. Instead, attach it to a permanent fixture on the tow vehicle using a sturdy carabiner or another strong removable connector.

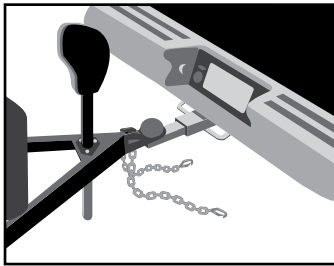

1. Inspect chains to determine if they are properly attached to the trailer frame.

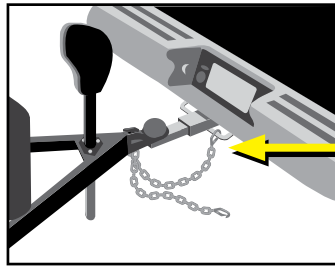

2. Connect driver side chain to passenger side mounting point on tow vehicle hitch.

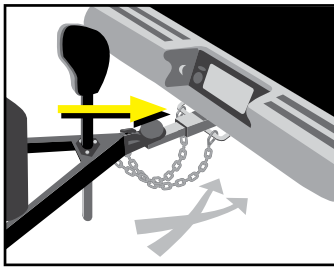

3. Connect passenger side chain to driver side mounting point on tow vehicle hitch. Chains should cross but not touch the ground.

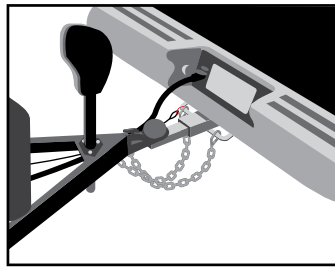

4. Properly mounted safety chains. Trailer plug and emergency brake line attached. Trailer jack raised.

FIFTH WHEEL PIN BOX (CUSTOMER SUPPLIED)

CAUTION (See page 18)

Selecting the right hitch is crucial for safe towing of your RV, especially for a fifth wheel. Consult your dealer to ensure compatibility with your tow vehicle and RV combination. For a fifth wheel, a pin box hitch bolted directly to the truck bed floor through the frame is necessary.

Consider your tow vehicle's bed length when choosing a hitch. Using an improper hitch, particularly on a short bed truck, may damage the truck when the trailer swings into the truck cab during tight turns.

Ensure the hitch package rating matches or exceeds the RV's GVWR and the pin box rating. Suspension systems that offer a softer ride for trucks may increase swaying when towing an RV, while overly stiff suspensions can lead to vibration and wear. Your RV manufacturer cannot oversee the tow vehicle's suspension system, so choose compatible suspension systems carefully.

Note that the fifth wheel's factory-installed pin box is not interchangeable. Maintain proper pin box weight on the hitch, and consult a professional to adjust the hitch to the correct height.

For further inquiries, discuss with your dealer, ensuring they are aware of your tow vehicle to achieve a compatible hookup.

Fifth Wheel Hitching Procedure

WARNING (See page 18)

The following procedure will help to assist you in securely hooking up your RV to your tow vehicle.

1. Chock the trailer wheels.
2. Make sure the hitch lever is in its open or "cocked" position unless it has been designed to open automatically.
3. Adjust the fifth-wheel travel trailer pin to the proper height by raising or lowering the landing gear.
4. Lower the tailgate, if applicable.
5. Back the truck so the hitch encircles the fifth-wheel/travel trailer pin. You may need to adjust the trailer pin height to be even with or slightly below the coupler.
6. Allow the hitch saddle jaws to gently contact and close around the pin.
7. Secure the hitch lever as specified by the manufacturer.
8. Put the truck in drive (DO NOT press on the accelerator) and 'bump' the hitch to make sure it is locked. After which, put the truck back in park.
9. Be sure to raise the fifth-wheel landing gear all the way up.
10. Attach the breakaway switch cable to the tow vehicle.
11. Plug the wire harness/connector plug from the tow vehicle to the fifth wheel.
12. Remove the wheel chocks from the trailer wheels.



Fifth wheel landing gear can be operated manually. The fifth wheel landing gear must be fully retracted before moving or towing the RV to prevent damage.

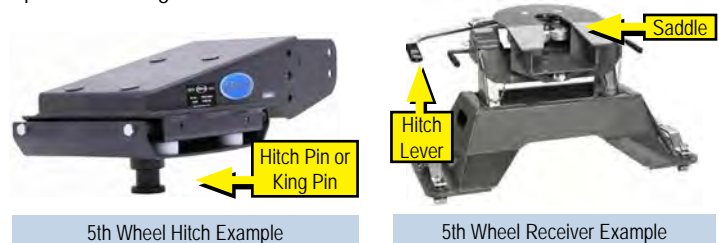

WEIGHING YOUR TOW VEHICLE AND RV

To ensure safe operation and warranty compliance, it's crucial to weigh your fully loaded RV, including all options, liquids, hitch weight, and personal cargo. Avoid exceeding the Gross Vehicle Weight Rating (GVWR). Balance and total weight are key factors.

Verify compliance with all applicable weight ratings to avoid voiding warranties. Periodically weigh your RV at a public scale to assess load distribution. Note that individual scales may operate differently, and ensure there's enough space on either side for accurate side-to-side weight measurements.

To Weigh Your Tow Vehicle And RV

⚠ WARNING ⚠ (See page 18)

Load your RV as you would for a typical trip, including food, clothing, fuel, water (if dry camping), propane, and supplies.

1. Weigh the RV, including the tongue weight, while it's detached from the tow vehicle. Ensure this weight is equal to or less than the Gross Vehicle Weight Rating (GVWR) for safe operation. Remove contents if necessary to meet this requirement.
2. Hitch the RV to your tow vehicle and weigh both together to determine the Gross Combined Weight (GCW). Ensure that this weight does not exceed the Gross Combined Weight Rating (GCWR) specified by the tow vehicle manufacturer. Remove items if needed to comply with this rating.
3. Weigh the RV while it's attached to the tow vehicle but excluding the tow vehicle's weight. This will give you the actual weight exerted on all RV tires, which can help determine the tongue weight. Subtract this weight from the RV GVWR to find the actual tongue weight.
4. With the RV still attached to the tow vehicle, weigh each wheel position separately to ensure none of the tires are overloaded. Adjust cargo if necessary to distribute weight evenly across all tires.

To Determine The Wheel Position Weight

1. Pull the RV onto the scale so only one side's tire(s) is on the scale. Record the weight. Your RV must remain as level as possible (even though one side is not physically on the scale).
2. To calculate the opposite side RV wheel position weight, subtract the first side's weight from the weight determined in step #3.

If there is a difference in the weights on one side of the RV as compared to weights on the other side, rearrange cargo to try to equalize the load and not overburden the suspension on one side.

Once actual weights are obtained, compare them to the **Weight Information Label** weight ratings to ensure you are below the posted minimum ratings.

See "WEIGHT TERMS" on page 13 and "LOADING YOUR RV" on page 14 for important weight information.

WIRE HARNESS/CONNECTOR PLUG

Your RV is equipped with a 7-way wire harness/connector plug, facilitating the transfer of electrical power from the tow vehicle during travel. This powers essential components such as the RV brakes, taillights, clearance lights, turn signals, and brake lights. It's crucial that the wiring for operating your brakes matches in size between the tow vehicle and RV, with the RV brake wiring typically using 12-gauge wire.

Extended use may lead to corrosion buildup on the connector plug, affecting electrical contact. Regular cleaning is recommended to maintain optimal performance. Keep the connector plug clean and shielded from road elements while traveling to prevent damage.

NOTE

A 12V circuit tester is recommended to verify the trailer connections.

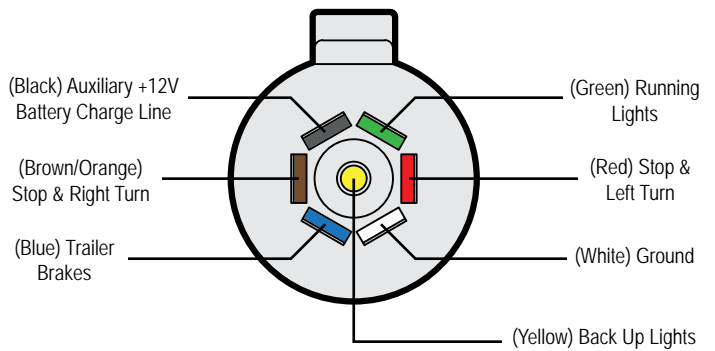

7-Way Trailer Plug (Cord End)



PRE TRAVEL INFORMATION



PRE TRAVEL INFORMATION DANGER

LOADING YOUR RV (See page 18)

Do not allow passengers to ride in the RV during travel. The RV does not have seat belts and is not designed to carry passengers. This may also be prohibited by state law.



PRE TRAVEL INFORMATION WARNING

VEHICLE LABELS (See page 13)

The factory-installed weight labels are specific to the recreational vehicle for which they are supplied and are not interchangeable. Do not remove these labels from your vehicle. If labels are missing contact your dealer or Customer Service for replacements.

Do not exceed any applicable weight ratings. Doing so could damage your RV or tow vehicle and adversely affect handling and braking characteristics.

LOADING YOUR RECREATION VEHICLE (See page 14)

Never load the RV in excess of the GAWR for either axle. Overloading your RV may result in adverse handling characteristics and damage to the RV.

DO NOT EXCEED YOUR GVWR! Weigh your RV when loaded for travel to determine the actual weight. If you exceed the GVWR, remove items or drain liquids to achieve a safe weight. Avoid traveling with full grey/black holding tanks, as it can affect handling and waste fuel.

Your recreation vehicle's load capacity is designated by weight, not volume. Load the vehicle evenly and secure heavy items to prevent shifting during travel.

Store items in designated storage areas, avoiding spaces reserved for converters, electrical panels, furnaces, or water heaters.

FIFTH WHEEL HITCHING PROCEDURE (See page 16)

DO NOT USE THE FIFTH WHEEL LANDING GEAR TO SUPPORT THE TOW VEHICLE WEIGHT. It is designed solely to bear the front loaded weight of the RV.

WEIGHING YOUR TOW VEHICLE AND RV (See page 17)

The combined weight of your tow vehicle and RV must not exceed the GCWR. Do not assume that a RV within the capacity of the tow vehicle hitch can be safely towed. This could lead to exceeding the total GCWR of your tow vehicle and RV combination.

Redistributing the load is crucial to prevent component failure, enhance vehicle handling, and avoid voiding the Towable Limited Warranty.



PRE TRAVEL INFORMATION CAUTION

REAR BUMPER (See page 14)

Do not affix items to the rear bumper of the recreational vehicle. Any aftermarket additions can cause damage to the bumper over time. Installation of such equipment or improper loading that results in damage will void the Towable Limited Warranty.

TRAVEL TRAILER HITCH (See page 15)

FIFTH WHEEL PIN BOX (See page 16)

Using an incorrectly sized hitch can damage the RV frame. The responsibility for the tow vehicle suspension system lies with the vehicle owner. Ensure the ball height is appropriate after the tow vehicle/travel trailer combination is fully connected. To prevent overloading of trailer axles and minimize handling issues, the trailer should be level when attached to the tow vehicle. Avoid overloading the tow vehicle.

SECTION 4: VEHICLE OPERATION



TOWING

⚠ WARNING ⚠ **⚠ CAUTION ⚠** (See page 34 & See page 36)

Traveling safely with your RV requires some adjustments to your driving habits. It takes longer for an RV to reach highway speeds than a regular car, so plan for extra time when passing other vehicles. Avoid sudden maneuvers as the length of the tow vehicle/RV combination affects your ability to maneuver quickly. When encountering dips, bumps, or railroad tracks, slow down to reduce jolting to your RV.

Be mindful of adverse weather conditions and terrain, as they can affect the performance and handling of your tow vehicle. Avoid using cruise control on icy or wet roads, winding roads, heavy traffic, or situations where constant speed cannot be maintained. When descending hills, use tow/haul mode or shift to a lower gear to control speed and reduce reliance on brakes.

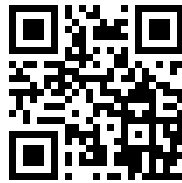

Know the weight and size of your towing combination and adhere to posted weight and clearance limits. The added height of roof accessories may cause clearance issues around tunnels, canopies, and signs. When turning, remember that the RV will make a tighter turn than the tow vehicle, so compensate by pulling the tow vehicle out further to clear obstacles.

When parking at your destination, choose a level site and back in carefully, ensuring there are no obstacles in your path. Once parked, set the tow vehicle parking brake and securely chock all RV wheels to prevent rolling.

RV Brake System

Exercise caution when braking in your RV until you are familiar with its stopping distance. Driving through water deep enough to wet the brakes can affect stopping distance or cause the vehicle to pull to one side. After encountering such conditions, test the RV's brake operation in a safe area to ensure they have not been affected. Never operate any vehicle if there is a noticeable difference in braking efficiency.

Electric Brakes

⚠ WARNING ⚠ (See page 34)

The electric brakes in your RV are designed to complement the tow vehicle brakes. For optimal braking performance, both the RV and tow vehicle brakes should be used simultaneously. Using the braking systems separately can lead to accelerated wear and damage.

When your RV is new, brake adjustment may not be precise. It typically takes around 1,000 miles or 50 medium to heavy stops to properly seat the brake shoes to the brake drum. Once broken in, brake shoes should be adjusted for optimal performance and longevity.

Braking System Components Include:

- Tow vehicle battery
- Tow vehicle brake controller
- Wire harness/connector plug
- Trailer battery
- Breakaway switch and alarms

The tow vehicle battery is crucial for powering your RV's electric brakes. Ensure that your tow vehicle battery and charging system are functioning properly to maintain sufficient power when needed.

Brake Controller (Customer Supplied)

To utilize the RV electric brakes, a brake controller must be installed in the tow vehicle. Consult your dealer or the brake controller OEM to determine the appropriate controller for your towing setup.

Breakaway Switch

⚠ CAUTION ⚠ (See page 36)

Your RV may come equipped with a breakaway switch, a critical component of the braking system. Typically located on the travel trailer A-frame or near the fifth-wheel pinbox, this switch engages the RV brakes if the trailer disconnects from the tow vehicle. When hitching your RV, attach the breakaway switch lanyard to a permanent part of the tow vehicle, not to removable parts like the hitch ball. If the RV disconnects, the pull pin activates the switch, engaging the brakes. **Ensure a battery (customer supplied) is installed to power the breakaway switch.**

VEHICLE OPERATION

TOWING BEHIND YOUR RV

⚠ WARNING ⚠ (See page 34)

NOTE

A hitch designed for trailer towing will feature tabs for hanging safety chains and a bracket for the trailer wiring plug. Additionally, it should bear a label indicating the maximum towing capacity. Hitches lacking these features are accessory receivers and should not be used for towing purposes. For more information see "CARGO CARRYING ACCESSORY RECEIVER (IF EQUIPPED)" on page 14.

Factory Installed Hitch Receiver (If Equipped)

If your RV (limited to certain fifth-wheel models) comes with a factory-installed hitch receiver, you can tow an additional boat or watercraft trailer behind it. The receiver functions as a weight-carrying hitch, but do not use a bar longer than 10" (254 mm). The maximum trailer tow rating is 3,000 lbs. (1361 kg.) with a maximum tongue weight of 300 lbs. (136 kg.). Additionally, you can attach a cargo basket/carrier, ensuring it's properly secured and not exceeding 300 lbs. (136 kg.) total weight. The towed trailer must have proper brakes; consult your dealer or manufacturer for braking system recommendations and state/provincial regulations.

Second Trailer Hitching Procedure

Follow these steps to securely hook up the second trailer to your RV:

1. Make sure the second trailer wheels are chocked.
2. Turn the tongue jack crank to raise the trailer tongue above the hitch ball.
3. Open the coupler latch on the trailer hitch.
4. Back the tow vehicle/ fifth wheel combination into the proper position.
5. Lower the coupler onto the hitch ball using the second trailer tongue jack crank.
6. Close the coupler latch securely.
7. Remove any dolly wheel or platform (if equipped) and retract the tongue jack to its maximum height.
8. Attach the breakaway cable to the hitch receiver on the RV fifth wheel.
9. Attach the safety chains. See "Travel Trailer Safety Chains" on page 16 for additional information.
10. Plug in the wire harness/connector.
11. Walk around the RV and the second trailer to ensure all exterior lights are functioning correctly.
12. Remove the trailer wheel chocks.

Wire Harness/Connector Plug

Your RV is equipped with a 4-way wire harness/connector plug to supply electrical power from the RV to the second trailer during travel.

This provides power to the taillights, clearance lights, turn signals, brake lights, and more. However, please note that the 4-way wire harness/connector is not wired to operate electric brakes.



With extended use, the connector plug may accumulate corrosion. It's important to clean it periodically to ensure proper electrical contact. Keep the connector plug clean and protected from road elements while traveling to maintain optimal functionality.

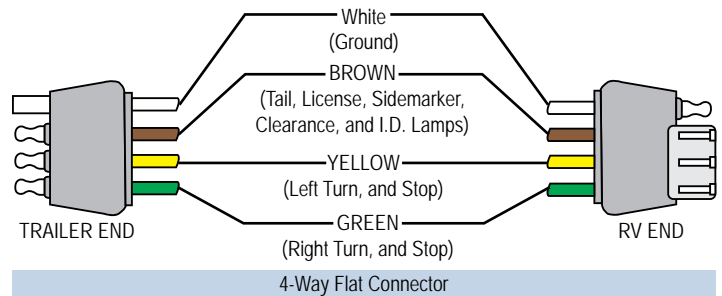

ENTRANCE DOOR STEP(S)

Make sure your entrance step is fully extended before exiting the vehicle, and retracted prior to towing.

Lubricating The Step Mechanism

1. Clean the area around the pivot points (the rivets involved in the step's motion) carefully.
2. Lubricate these pivot points with an automotive-grade, non-staining lubricant every 30 to 60 days.
3. Wipe off any excess lubricant from the step, and clean the entire step after lubrication.

STEP LIGHT

Your RV may be equipped with a switch located on the skirt (in front of the steps) which operates a light located under the step assembly.

STOWABLE ENTRANCE DOOR STEP

⚠ WARNING ⚠ (See page 34)

Your RV may be equipped with one or two sets of stowable entrance steps. These are one-piece assemblies with 2 to 4 steps each, which latch inside the doorway of the RV. The steps can be rotated down and out of the doorway and feature two adjustable feet to enhance stability when parked on rough terrain.

Step Operation

1. Open the entrance/screen door all the way.
2. Twist the locking handle to release the steps from the locked position on the door frame (A).
3. Lower the step assembly to the ground (B). If the step will not drop fully with the legs fully raised, you may need to dig out the landing area to help the steps clear the door.
4. Adjust the feet to stabilize the steps (C).
5. Remove pins (D) on each side of the step to adjust the legs, then reinsert the pins to lock the legs. If the feet do not reach the ground, use wood or stone blocks to achieve a firm and level contact.

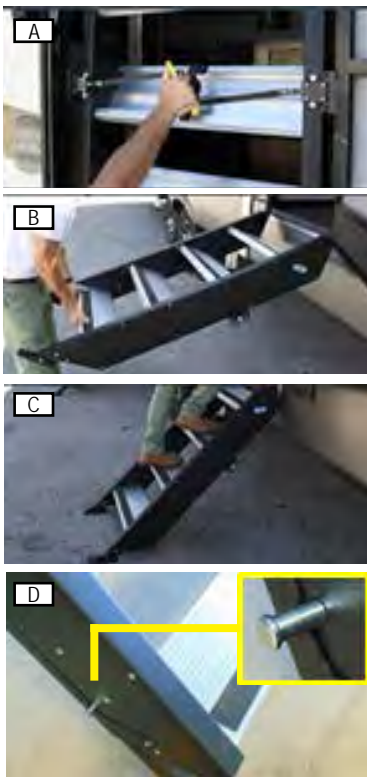

ENTRANCE DOOR

⚠ CAUTION ⚠ (See page 36)

Always hold onto the entrance door when opening or closing it. Damage caused because you failed to do so is not covered by the Limited Warranty.

The entrance screen door may be equipped with a slide panel that allows access to the entrance door handle and locks. The entrance door may also be equipped with both a regular door lock and a dead bolt lock.

Keys

Several keys are provided when you purchase your vehicle. Most keys have an individual key number stamped on the plate. Record these key numbers in the log below and in another safe place that you can access if locked outside of the vehicle. You can order a key blank from your dealer to have duplicate keys made. If you lose the keys, contact your dealer or a locksmith for assistance.

KEY LOG

Maintenance

Locks on entrance and baggage doors need biannual lubrication using a light coat of silicone spray. Conditions such as rain, salt, dust and pollution may increase the maintenance needs.

NOTE

Depending on the model, the step adjustment pin may be located on the side of the step system, or on the front where each leg attaches to the side rails.

Step Storage

1. Ensure the RV is unoccupied.
2. Fold the handrail at the door out of the way or remove the optional step handrail (if equipped).
3. Pull pins from adjustable legs (D) and retract the legs to fit inside the doorway when steps are folded. Reinsert the pins to lock the legs.
4. Lift the steps and rotate them up into the doorway.
5. Steps will automatically latch into brackets on each side of the door frame as they are lifted in place.
6. Close the entrance/screen door.

NOTE

When returning steps to the stored position, the adjustable feet may have to be retracted to fit inside the door opening.



VEHICLE OPERATION

LEVELING SYSTEM (IF EQUIPPED)

⚠ WARNING ⚠ (See page 34)

The Leveling System is an electric 4 or 6-point automatic leveling control. It utilizes one main control board and a separate waterproof remote level sensor to measure and manage level points. The system can be operated by the Auto Leveling Control Touch Pad, which is mounted outside the RV within view of the hitch.

For complete safety and operating instructions, refer to the manufacturer's user manual included in your Customer Information Packet.

Auto Leveling Control Touch Pad

A - Red/Green LED indicates system status

B - Up Arrow extends front jacks (landing gear)

C - Down Arrow retracts front jacks (landing gear)

D - Auto Level button places system in the auto level mode

E - Hitch Height button initiates the Hitch Recognition feature

F - Retract All button puts leveling system in full retract mode

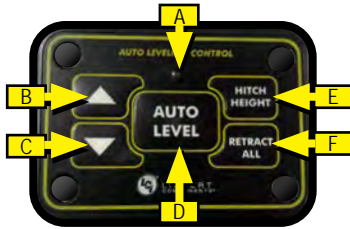

NOTE

Pressing both the arrow buttons simultaneously turns on the touchpad. Touchpad will time out after 7 minutes of non-use.

Auto Level Touchpad LED Indicator Status

- **OFF** - Touch pad is locked
- **Solid Green** - Touch pad is active
- **Blinking Green** - Jacks are moving
- **Solid Red** - Low battery
- **Blinking Red** - Error

The OneControl touch screen or Leveling App will show the specific error.

Refer to troubleshooting section of the manufacturer's manual to clear the error.

Unhitching the RV

1. Before unhitching from the tow vehicle, ensure the RV is parked on a level surface and tires are chocked.
2. Extend the inner legs of both landing gear (front jacks) to within 4" - 5" of the ground by pulling on the quick release pins.
3. Turn on the touchpad by pressing both arrow buttons simultaneously. LED illuminates solid green.
4. Press the UP arrow button to extend the front jacks to lift the front of the RV taking weight off the hitch.
5. Uncouple the RV connection to the tow vehicle. Pull tow vehicle away.

Auto Leveling

When the leveling cycle starts, ensure there is no movement inside the RV until leveling is complete. Movement during leveling may affect the system's performance.

1. Turn on the touchpad. THE LED will light up solid green.
2. Select AUTO LEVEL and the auto leveling process begins. Front of the RV will seek a position near level. Rear jacks will be grounded (on 4-point system). Side to side leveling will begin.
3. Each jack will perform a final grounding touch.

On a 6-point system, the (2) middle jacks will be grounded to stabilize the trailer. The (2) middle jacks do not level the RV.

If the AUTO LEVEL sequence does not proceed as described, switch the system to manual mode and test the jacks' operation using the OneControl touch panel inside the RV.

STABILIZERS

⚠ WARNING ⚠ (See page 34)

Each stabilizer can be individually adjusted to stabilize the RV for use. Make sure the RV is level BEFORE using the stabilizers.

When setting up on soft ground, consider placing a wood pad or equivalent under each stabilizer foot to prevent sinking.

Manual Stabilizers (if equipped)

Lowering: Insert the crank onto the stabilizer shaft and turn clockwise until the leg contacts the ground.

Raising: Insert the crank onto the stabilizer shaft and turn counter-clockwise to retract the leg.

Jayco Rock Solid Stabilizer System (if equipped)

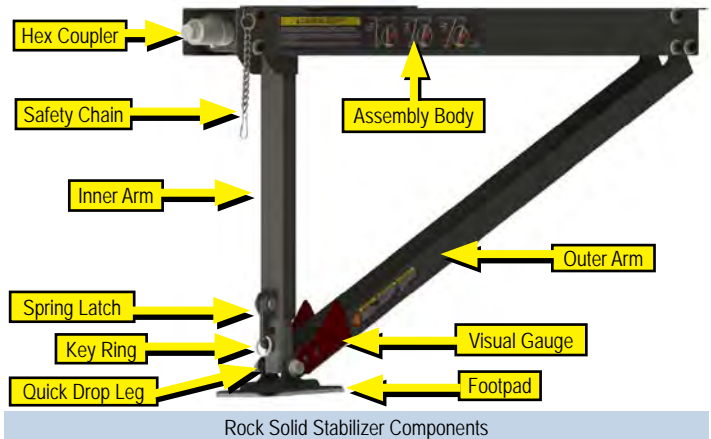

Extending Stabilizers

1. Disconnect the safety chain from the footpad (Fig. A).
2. Using a 3/4" socket on a ratchet or cordless drill, turn the hex coupler (Fig. B) clockwise to lower the foot pad towards the ground.

NOTE

Use of an impact drill is not recommended and will cause damage to the mechanism.

3. Once the footpad has extended partially, pull the spring latch (Fig. C) and lower the Quick Drop Leg to position the foot pad closer to the ground.
4. Continue turning the hex coupler clockwise until the footpad touches the ground and resistance is felt. Adjust the Quick Drop Leg as needed for optimal stabilization (Fig. D). Ensure a gap between the Visual Gauge and the Inner Arm for correct positioning, aiming for a near-vertical inner arm.

NOTE

Upon completion, the inner arm should not have moved beyond a 90 degree angle; perpendicular to the assembly body. Doing so may cause the mechanism to bind and cause damage.

5. Repeat the process for the remaining stabilizer legs.



Retracting Stabilizers

To retract the stabilizers, reverse the process above, remembering to retract the Quick Drop Leg after raising the Foot Pad so the stabilizer does not stick out from the sides of the RV during transit, and re-attach the Safety Chain.

Electric Stabilizers (if equipped)

Control switches for the stabilizers are typically located on the (door) side of the unit above the stabilizer jack(s). To lower each stabilizer, press the control switch until each leg contacts the ground and stabilizes the unit. To raise the stabilizer, press the control switch until the stabilizer is returned to the retracted position.

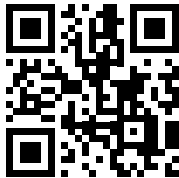

Manual Override

The electric stabilizers may have a built in manual override system.

1. Disconnect the battery from the system before engaging in manual operation.
2. Locate the override coupler, which is typically situated on the end of the stabilizer opposite the electric motor.
3. One of the wire motor leads must be disconnected to prevent backloading the motor and causing damage.

4. Insert the provided 1/2" diameter crank handle into the coupler. Ensure the slot in the end of the crank handle accommodates the pin inside the coupler.
5. Rotate the crank handle clockwise to retract the stabilizer and counterclockwise to extend it manually.

NOTE

The gears can be stripped out if the stabilizer is manually retracted/extended to its fullest extent and the operator continues to rotate the manual override.

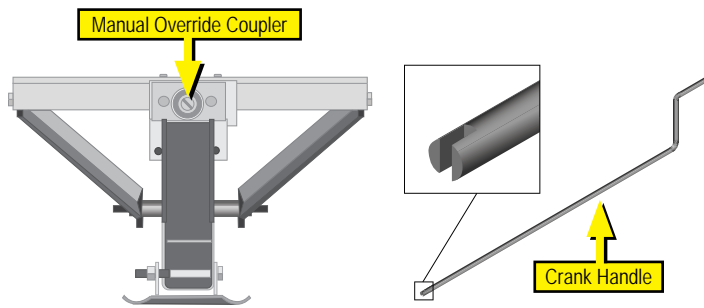

Electric Stabilizer Manual Override

TANDEM AXLE FLEX EQUALIZER (IF EQUIPPED)

Your recreational vehicle may be equipped with a tandem axle flex equalizer on the leaf spring suspension. These units may have grease zerks attached to the head, and should be greased approximately every 3500 miles. Check with the component manufacturer for additional information.

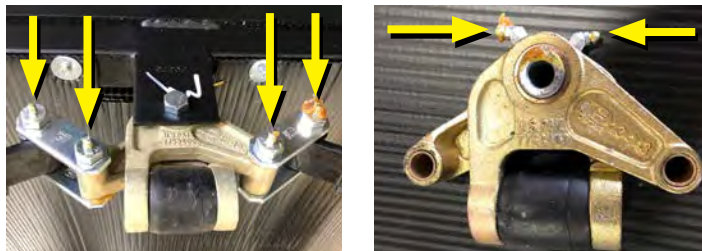

Example Tandem Axle Flex Equalizer Grease Zerk Points



VEHICLE OPERATION

EMERGENCY STOPPING

⚠ WARNING ⚠ (See page 35)

Always carry road flares or reflective warning signs. Pull off the roadway as far as possible for emergency stopping. Turn ON your vehicle hazard warning flashers. If traveling at night, use three red warning indicators such as flares, reflectors, or lanterns as required by the Uniform Vehicle Code and Model Traffic Ordinance.

NOTE

Curves and hills may affect the safe placement of warning indicators.

EMERGENCY TOWING

⚠ WARNING ⚠ (See page 34)

If your recreational vehicle needs to be towed, please contact an emergency road service provider or a qualified service facility for assistance.

WHEEL LUGS

⚠ WARNING ⚠ (See page 34)

After your first trip, periodically check wheel lug torque for safety, including after winter storage, wheel removal, before trips, and following extensive braking. Tighten lug nuts in two stages, using the correct star pattern sequence to attach RV wheels. Begin by hand and follow the specified tightening sequence.

Use a properly calibrated torque wrench and socket, not an impact wrench or hand tightening, to tighten wheel lug nuts. Avoid using a 4-way lug wrench or other tools that don't measure applied pressure. Follow the correct lug pattern on your wheels, as shown in the Wheel Lug Nut Diagram

Lug Nut Pattern and Warning Label

The lug nut pattern and warning label can be found on the driver side front or front sidewall of travel trailers, and on the driver side of the pinbox on fifth wheel units. The lug pattern label varies based on the number of wheel lugs



Torque Wrench Usage

1. Maintain tools properly and store them correctly.
2. Do not use accessories or extensions unless permitted by the manufacturer.
3. Apply torque steadily in a downward direction, avoiding sudden movements.
4. Stop immediately when the wrench signals that the specified torque has been reached.

Wheel Lug Nut Diagrams

Because of the importance of having proper torque on the wheel lug nuts, you should always have the wheels mounted and properly torqued by a qualified technician using the proper tools.

Criss cross "star" patterns, as shown, must be followed during tightening sequence.

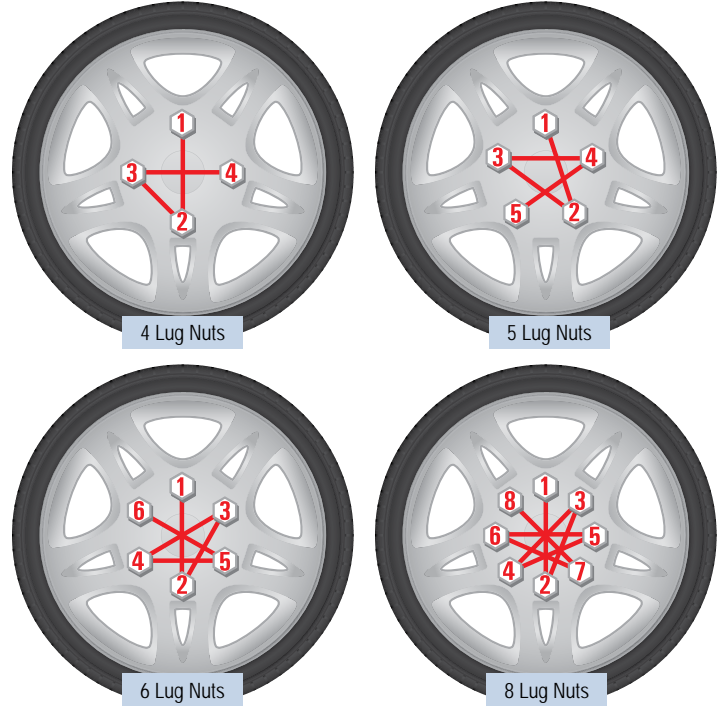

A Digital or Dial Torque Wrench is recommended.

Also applies to any service involving wheel or lug removal, during the life of the recreational vehicle. Start the lug nuts by hand.

Lug Nuts	Stud Size GR 8	Rim Size	Rim Type	Stage 1 Torque Values	Final Torque Values
4-Lugs	1/2"-20	12"	Steel/Alum	45 ft lbs	70 ft lbs
5-Lugs	1/2"-20	12"-13"	Steel/Alum	45 ft lbs	70 ft lbs
5-Lugs	1/2"-20	14"-15"	Steel/Alum	65 ft lbs	120 ft lbs
6-Lugs	1/2"-20	15"-16"	Steel/Alum	65 ft lbs	120 ft lbs
8-Lugs	1/2"-20	16"	Steel/Alum	65 ft lbs	120 ft lbs
8-Lugs	9/16"-18	16"	Steel/Alum	65 ft lbs	120 ft lbs
8-Lugs	9/16"-18	17.5"	Steel/Alum	65 ft lbs	120 ft lbs

TIRES

CAUTION (See page 36)

Before your first trip with your RV, it's crucial to comprehend the following guidelines regarding your tires. Regular maintenance of your RV is essential, with tire inspection and pressure checks being paramount for safety. Alignment, balance, and bearing wear can impact tire longevity. Be vigilant for signs such as cracking, bulging, or uneven tread wear.

Tire Wear Diagnostic Chart					
Center Wear	Edge Wear	Side Wear	Toe Wear	Cupping	Flat Spots
Cause					
Over inflation	Under inflation	Loss of camber or overloading	Incorrect toe-in	Out of balance	Wheel lock-up & tire skidding
Action					
Adjust tire pressure to particular load, per tire catalog.	Adjust tire pressure to particular load, per tire catalog.	Insure load does not exceed axle rating. Align at alignment shop.	Align at alignment shop.	Check bearing adjustment & balance tires.	Avoid sudden stops when possible and adjust brakes.

Tire Pressure

DANGER **WARNING** (See page 34 & See page 35)

It's crucial to adhere to the manufacturer's inflation guidelines to ensure maximum load capacity. Both under-inflation and over-inflation pose risks. Regularly monitor tire pressure to prevent overheating, which could lead to a blowout. Check inflation weekly when the tires are cold, as pressure increases during travel due to heat buildup. Avoid bleeding air from hot tires to prevent them from becoming under-inflated.



TIRE PRESSURE MONITOR SYSTEM (TPMS) (IF EQUIPPED)

WARNING **CAUTION** (See page 35 & See page 36)

Your RV may be equipped with a Tire Pressure Monitoring System (TPMS). The system has sensors installed on the tire valve stems. Tire temperatures and pressures are displayed only on the JayCommand/TravelLINK Smartphone App, which connects through Bluetooth to your BMPRO control system. There is no TPMS page on the BMPRO Mini control panel screen inside the RV.

NOTE

Cold tire inflation pressure is defined as a tire that has not been used for three or more hours, or has been driven less than one mile. Tire inflation pressure of a hot tire may show an increase of as much as 6 psi over a cold tire.

Rotating The Tires:

When rotating tires equipped with TPMS sensors, ensure screw-on sensors remain in their original positions on the trailer. Internal sensors are paired to specific tires. To change pair positions in the JAYCOMMAND/TravelLINK Smartphone App, access the sensors page, unpair all tires, then individually pair each tire following on-screen instructions.

CHANGING A TIRE

⚠ WARNING ⚠ (See page 35)

If you experience a flat tire on your RV while driving, gradually decrease your speed and move the recreational vehicle to a safe, level place on the side of the road.

1. Keep the RV connected to the tow vehicle and use chocks on the opposite tire.
2. Loosen the lug nuts on the flat tire, but do not remove them completely.
3. Position the jack under the main frame rail just before the front or after the rear tire.
4. Lift the tire off the ground using the jack.
5. Remove the loosened lug nuts and replace the tire with the spare.
6. Hand-tighten the lug nuts onto the spare tire.
7. Lower the jack until the spare tire touches the ground.
8. Fully tighten the lug nuts in the proper sequence and torque values.
9. Remove the chocks from the opposite tire.
10. Store the damaged tire for repair or replacement.

Tire Replacement

If you require tire service or warranty coverage, it must be addressed directly with the tire manufacturer or the retailer that supplied the tires for your RV. Do not return tires to your dealer or RV manufacturer for service.

For inquiries about your tires, please reach out to the tire manufacturer directly.

SPARE TIRE CARRIER (IF EQUIPPED)

⚠ WARNING ⚠ (See page 35)

If your RV is equipped with a spare tire, it will either be mounted under the unit (hoist) or on the rear bumper.

Hoist Mount

The spare tire will be mounted against the underside of the recreation vehicle (flush mount) using a cable hoist to give it stability in travel.



NOTE

If your spare tire is a flush mount application, it must make contact with the underside of the recreational vehicle to insure maximum road clearance and stability in travel.

Raising And Lowering The Hoist

Locate the crank handle stored in the storage under the master bed or in a basement compartment of the RV. Insert the crank handle into the crank access port (A), typically located in the center of the rear bumper or on the RV sidewall. Ensure proper alignment by checking under the skirting if needed. Turn the crank handle to raise or lower the tire. Verify that the tire is securely seated for travel, with the hoist lift (B) positioned firmly in the center of the tire.



Rear Bumper Tire Carrier

1. Remove the spare tire cover (if equipped).
2. Remove the lug nuts holding the tire in place.
3. Remove the support bracket from the bottom lug.
4. Pull the tire from the tire carrier.

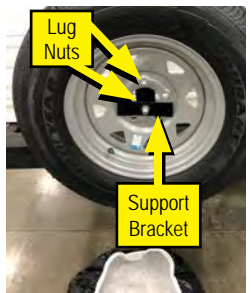

Bumper Mounted Spare Tire

To reinstall the spare tire, reverse the steps above.

Vinyl Tire Cover (if equipped)

Your tires are manufactured with components that cause "bleeding" onto the tire cover. To prevent this, it is recommended to use a separator (garbage bag, paper, cloth, etc.) between the tire and the cover.



VEHICLE OPERATION

SETTING UP YOUR RECREATION VEHICLE

⚠ CAUTION ⚠ (See page 36)

Position the RV as desired in a location that is mostly level from side to side, has clearance for slide-outs, allows for clear and solid placement of stabilizer and tongue jacks, and allows for safe movement around the outside of the vehicle.

Level the RV (side-to-side). Leveling your recreation vehicle is important as the water drainage systems are designed with proper slope and must be level for proper operation, and the appliances perform best when level.

Travel Trailer Set Up

1. Make sure the tow vehicle is in park, and chock the wheels securely to prevent the RV from moving.
2. Unhook the wire harness/connector plug, safety chains, and breakaway switch lanyard.
3. Install the dolly wheel or platform.
4. Release the weight distributing bars (customer supplied).
5. Open the tongue jack coupler latch.
6. Raise the tongue jack to lift the coupler above the hitch ball.
7. Pull the tow vehicle away.
8. Level the RV (front-to-back) with the tongue jack.
9. Extend slide outs then lower the stabilizer jacks.

Fifth Wheel Set Up

1. Make sure the tow vehicle is in park, and chock the wheels securely to prevent the RV from moving.
2. Lower and secure the landing gear.
3. Lower the tailgate.
4. Raise the landing gear so the weight is off of the hitch plate. There should be a small gap (about 1/8") between the pinbox and the receiver.
5. Gently put your truck into reverse (do not give it any fuel/ acceleration). This effectively moves the kingpin off the locking bar that will allow you to disengage it.

6. Step on brake, put the vehicle in park, and apply parking brake.
7. Disconnect the wire harness/connector plug and breakaway switch lanyard. Stow them out of the way.
8. Disengage the locking bar and unhitch.
9. Pull the tow vehicle away.
10. Adjust the landing gear height for proper front to back leveling of the RV.
11. Extend slide outs and then lower the stabilizer jacks.

CAMPSITE HOOK-UP

- Refer to "SECTION 6: ELECTRICAL" on page 40 before connecting the shore line power cord (when using full hook-up) OR before starting the generator (if equipped) or operating the vehicle on 12-volt power when dry camping.
- Refer to "SECTION 7: FUEL & PROPANE SYSTEM" on page 55 before using the LP system. Open the LP gas tank valve (if equipped) slowly. There may be air in the lines and five to thirty seconds of time is needed to bleed air before LP vapor fills the lines.
- Refer to "SECTION 8: PLUMBING SYSTEM" on page 60 before connecting the fresh water supply or turning ON the water pump or water heater.
- When using full hook-up, connect the sewer hose to the campsite sewer hook-up.
- If applicable, start the refrigerator and the cooling or heating system.



NOTE

For extended dry camping, management of all your resources is essential. Check your battery levels and conserve battery power.



VEHICLE OPERATION

SEASONAL SET-UP (BUNGALOWS ONLY)

If you are setting up in a seasonal campsite, consult your authorized dealer for guidelines in properly setting up your bungalow travel trailer. Proper set up will insure your safety along with getting the most effective use from your RV and its features.

You should also familiarize yourself with all site requirements and local zoning ordinances that may apply.

When Setting Up Your Seasonal Campsite Make Sure:

- The campsite is properly graded and sloped to prevent water accumulation under the travel trailer.
- All load bearing supports and footings meet the local enforcement agency requirements for size, capacity and application.
- Grass and organic material from the area is removed from under supports or footings.

Frame Support

The bungalow may rest on the tires and hitch jack as needed, but for long term use where you might want a more stable base, additional frame supports will be needed to isolate the frame from the suspension. **PROFESSIONAL INSTALLATION IS HIGHLY RECOMMENDED.**

The following process can be used when placing the unit on a site that has been designed for the location of an RV where either a Concrete Slab, Pier, or Footing has been provided. In areas where these foundations have not been provided, the ground conditions need to be adequately evaluated and a determination needs to be made regarding the load bearing capacity and possible improvements that may be needed.

1. Locate the trailer in its final position and chock the tires securely.
2. Place a level on the floor in the unit running front to rear and use the hitch jack to bring the unit to a level position.
3. Turn the level 90 degrees to run from side to side on the unit floor.
4. On one side of the RV, using 2 hydraulic jacks with a minimum load capacity of 5 tons (user provided), place one jack under the frame, forward of the front spring hanger and the other rearward of the rear spring hanger.
5. Begin lifting the unit using the hydraulic jacks alternately lifting no more than 1" on each jack. Place support piers forward and rearward of these jacks placing hardwood cribbing to within 1/4" of the I beam for each pier.

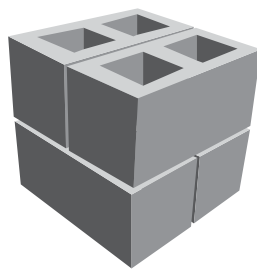

Concrete Block Pier Example

NOTE

We recommend using 8"x8"x16" concrete blocks stacked alternately for use as piers. Use hardwood cribbing to fill the gaps between your piers and the frame.

6. Lower the hydraulic jacks so the I beam rests on the hardwood cribbing.
7. Locate the two hydraulic jacks on the opposite side of the unit in the same relative locations, forward and rearward of the spring hangers. Begin lifting the unit up alternately using the jacks, lifting no more than 1/2" at a time on each jack. Bring the unit to a position that is level as indicated by the level placed on the floor of the unit.
8. Raise each jack an additional 1". Place piers and hardwood cribbing in the same manner with the cribbing brought to 1" from the I beam. Lower the hydraulic jacks so the I beam rests on the hardwood cribbing.
9. Turn the level to its original position running front to rear in the unit and make any minor adjustments to level with the hitch jack if needed.
10. Additional Piers should now be located under the I beams at the front and rear of the unit within 3 feet of the end of the I beams. The jacks can be used to lift the I beams up a small distance so that the cribbing can be placed on top of the piers and the jacks lowered to rest securely on the supports at the front and rear with the loads transferring into the added piers.

NOTE

It is not necessary to lift the RV tires off of the ground or remove them. If the RV tires are removed, additional supports will need to be installed under each axle.

Tie-Downs

All bungalow travel trailers should be securely anchored to the ground with (6) tie-downs and ground anchors (minimum 3 per side), to resist the sliding and overturning effects of high winds. Where tie-downs are required, it will be necessary to adhere to the following instructions.

All bungalow travel trailers are equipped with tie-down attachment provisions on the main "I"-beams. Any one of the three methods featured may be used.

In the tie-down system, it is important to use materials of proper design and adequate quality. The following material specifications should be considered as minimum requirements.

The following materials, not furnished with the travel trailer but are necessary to complete the tie-down system, **must meet the listed requirements.**

1. Cable or steel strap with a breaking strength of at least 4,725 lbs., e.g. galvanized aircraft cable at least 1/4" in diameter or Type 1, Finish B Grade 1 steel strapping, 1 1/4" wide and 0.035" thick, conform to F.S. QQ-S-781-H.
2. Galvanized connection devices such as turnbuckles, eye bolts, strap buckles and cable clamps should be rated at 3,150 lb. working load minimum.
3. Ground anchors capable of withstanding at least a 4,725 lb. pull. **Anchors must be installed as specified by the anchor manufacturer.**

THE UNIT MUST BE IN ITS FINAL LEVEL POSITION PRIOR TO TYING IT DOWN.

VEHICLE OPERATION

Leveling your recreation vehicle is important as the water drainage systems are designed with proper slope and must be level for proper operation, and the appliances perform best when level.

Tying Down The Travel Trailer:

1. Position and install the ground anchors to line up with the provided tie-down brackets.
2. Connect the straps to the frame and ground anchors.
3. Tighten the straps using the tensioning device provided with the ground anchors. Use caution to avoid over-tensioning the straps as this may pull the trailer off the piers. Straps should be tightened only enough to remove the slack. **After all the straps are installed and the slack removed, tension the straps.**

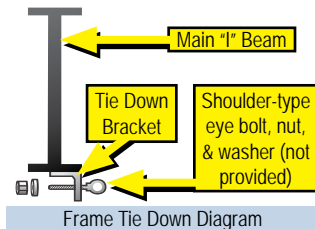

The strap tension should be rechecked at frequent intervals until all pier settlement has stopped.

During the re-leveling process, do not jack the travel trailer against tight straps.

Inspection Checklist

Once the bungalow travel trailer has been set up for long term seasonal camping, the following items should be checked for proper set up prior to occupancy.

- Installation / Placement
- Utility Connections
- Level
- Fuel
- Foundation
- Water
- Tie Downs
- Electric
- Sewage

Detachable Hitch

Some units come with a detachable hitch. If detachable, the hitch A-frame will be bolted to the underside of the trailer frame. The instructions to remove and install it are listed below:

Suggested Materials (Customer Supplied):

Quantity	Item Description
4	3-ton jack stands
2	7/8" open end wrench
1	3/4" socket and drive
1	3/8" socket and drive
4	Wood blocks or tire chocks

1. Chock tires on both sides of trailer.
2. Unscrew flexible gas hose from main bulkhead on front steel crossmember and cap both fittings.
3. Remove gas bottles from tongue.
4. Remove electrical wiring and safety break-a-way switch from tongue by removing 3/8" screws (could be 3 or more).
5. Coil wires up and place behind front crossmember.
6. Raise tongue up with tongue jack.
7. Place 2 jack stands (3-ton minimum rating each, one on each side of the trailer) approximately 4' behind the front crossmember under the main I-beam.
8. Lower frame down onto jack stands.
9. Place another (2) jack stands (3-ton minimum rating each, one each side of tongue) under tongue between (2) tongue connection plates.
10. Remove tongue from trailer by removing 3/4" bolts and nuts (4 per connection plate, 16 total).

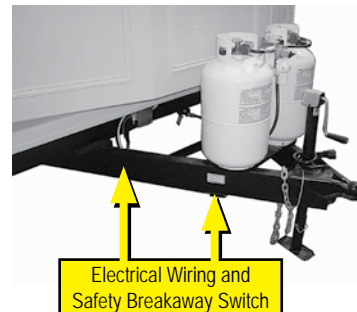

To reinstall the hitch, reverse these steps (tighten the bolts to 60-70 ft/lbs torque). It is your responsibility to take your travel trailer to the dealer for warranty or service repair.



VEHICLE OPERATION

CARGO RAMP DOOR

⚠ WARNING ⚠ (See page 35)

When using the cargo ramp, it's crucial to adhere to the maximum weight and occupancy capacity specified on the nearby decals. The ramp door is equipped with spring assistance to facilitate its opening and closing. Prior to opening the ramp door, ensure that the chosen unloading site offers a level and flat surface for the door to rest on. Additionally, make sure to chock the RV wheels to prevent any movement, and clear the area of any people, pets, or equipment that may obstruct the ramp's operation.

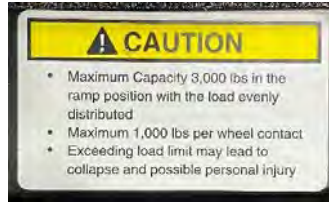

Ramp Weight Warning Decal Examples

Manual Ramp Door

1. Lessen the transition angle between the rear of the cargo floor and the cargo door ramp by using the tongue jack to raise the front of the trailer. To prevent damage to the ramp door and extension ramp this should be done prior to lowering the cargo ramp door.
2. Unlock the Tailgater Kitchen (if equipped) and swing it away from the rear ramp door.
3. Unlock the exterior vise latches securing the bar latch handles.
4. Push up on the bar latch handles that hold the ramp door in place, and move them to the outside of the trailer to avoid contact when opening the ramp door.
5. Using caution, pull the ramp door open. Support the ramp door at all times and do not let it drop to the ground.

NOTE

For automated ramp doors (if equipped), turn the keyed power switch ON, then press and hold the momentary switch to lower the door.

To Close The Manual Ramp Door

Ensure that stored vehicles or equipment do not damage the ramp door seals during loading. Remove any debris, such as sand or snow, from around the ramp door before closing it. To close the ramp door, follow the steps in reverse order. Secure the ramp door by locking the vise latches.

NOTE

Do not move the RV until the cargo ramp door is closed and secured.

Manual Ramp Door Support Cables

The manual ramp door can be closed with the patio support cables attached to the ramp door and the door frame. Inspect all ramp door components for wear or damage before each trip. If repairs are needed, contact your RV dealer for a service appointment.

Automated Ramp Door (if equipped)

Your RV may be equipped with an automated ramp door. Follow all precautions and warnings listed previously for the manual ramp door.

Exterior Keyed Switch

The automated ramp door is operated with a keyed switch located on the outside of the RV (off door side) next to the shore power plug. Insert the key in the key switch and turn it ON.

Press and hold the momentary switch down to lower the ramp door. The switch must be held until the door is completely lowered. If you release the switch, the door will stop until the switch is pressed and held again.



Keyed Switch

With the key ON, press and hold the momentary switch UP to raise the ramp door. When the ramp door is closed, release the switch and turn the key OFF.

Automated Ramp Door Support Cables

⚠ WARNING ⚠ (See page 35)

Ensure that the cables used to hold the ramp door in the patio configuration are removed from the door when not in use. Failure to remove the cables when closing the door may interfere with the latch mechanism, preventing proper closure and potentially causing damage.

To remove the cables, release the top end of each cable by unscrewing the quick links (A) holding them to the door frame. Remove both the cable and the quick link together from the top of the door on each side. Do not leave the quick links on the door frame.

To release each cable at the side of the ramp door, unclip the safety pins (B) and slide the pins out of the door bracket. Do not reinsert the safety pins into the door bracket.

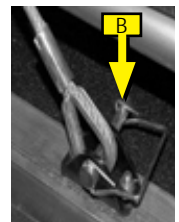

LOADING THE CARGO AREA

⚠ WARNING ⚠ (See page 35)

To ensure safe towing and travel, careful attention must be paid to loading the cargo area. Take caution not to exceed the weight capacity of the cargo ramp, cargo area, and the GVWR of the RV. Additionally, ensure compliance with all towing requirements of your tow vehicle by referring to its owner's manual.

Weight Distribution

Evenly distribute the load when loading the cargo bay area to prevent adverse effects on towing and handling. Follow these guidelines:

- Load the cargo bay from front to back, placing heavier vehicles/items toward the front.
- Distribute all vehicles/equipment evenly from side to side in the cargo bay.
- Secure all vehicles/items to prevent load shifts during transit.

Ensure all vehicles/items in the cargo area are securely tied down and the cargo door is locked before transit.

Air Vents

Typically (2) air vents are located on either side of the cargo bay and are designed for airflow and ventilation when there is fuel powered equipment in the cargo bay. **The vents must remain open any time equipment is loaded in the cargo bay, including during travel.**

NOTE

Both vents should be open to prevent gas fumes from building up in the recreation vehicle. The upper vent should be positioned to draw air into the unit, and the lower to direct the air out when the unit is in motion.

To open the vent(s), firmly grasp the vertical bar in the middle of the vent, and push or pull it to the left or right until it clears the notch in the pivot base as shown below and the vent will open. To close it, pull the handle until it returns to the center of the pivot base.

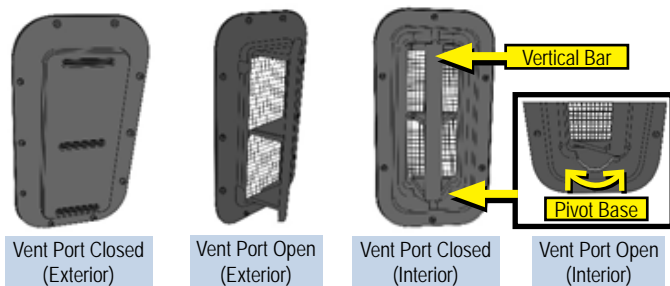

PATIO DECK - REAR (IF EQUIPPED)

⚠ WARNING ⚠ (See page 35)

Unlatch and swing the Tailgater Kitchen (if equipped) (attached to the rear of the RV) out of the way to lower the rear ramp door.

Manual Ramp Door

Patio support cables are connected to both the ramp door and the door jamb. The door is designed to close with the support cables attached. However, the support cables must be detached from the door to lower it and utilize it as a ramp. Re-attach the support cables before closing the ramp door.



Automated Ramp Door

⚠ CAUTION ⚠ (See page 36)

Before closing the ramp door, ensure that the RV is level. Detach the patio support cables from both the ramp door and the door frame. This includes removing the quick links from the door frame, releasing the safety pins on the ramp door, and disconnecting the cables themselves.

Set up the Patio Deck (Automated Ramp Door)

Locate and secure the cables to both sides of the door frame and cargo door, by fastening one end of the cable to the top of the door frame using a quick link fastener. Tighten the nut on the quick link fastener once the cable is in place. Lifting up the door slightly, secure the other end of the cable to the cargo door by inserting the safety pin through the bracket and cable. Secure the safety clip on the end of the pin. Repeat the process on the other side of the door.

Side Rail Setup for Manual and Automated Doors

⚠ CAUTION ⚠ (See page 36)

To set up the side rails, remove the safety pins (2 per post) from the bottom of the rail posts. Lift the rail to the upright position and secure it in place by inserting a safety pin through each hole in the bracket and the rail. Secure the triangular wire safety clip on the end of each pin. Repeat the process on all corner rail posts.

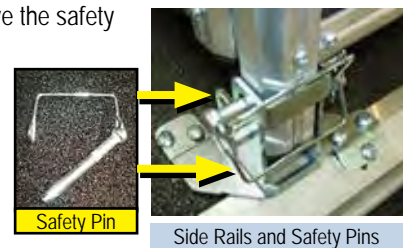

The patio deck is equipped with mesh end curtains that snap to the door jamb of the rear cargo ramp door (or the side patio door jamb) and to the frame work of the railings. These curtains close off the gap between the railing and the door jamb.



VEHICLE OPERATION

Retractable Screen Wall (if equipped)

Before extending the screen wall, ensure all obstacles are removed from its path. To extend the screen wall, grip the strap attached to the pull bar and gently pull down. Continue pulling until the screen wall is fully extended and securely attached to the floor catch.

To retract the screen wall to its stored position, pull up on the pull bar handle to release it from the floor catch. Push the screen wall up until it is fully retracted.

To prevent injury or damage to the screen wall, ensure it is fully extended and snapped in place at the floor when in use, and fully retracted when not in use.



Retractable Screen Wall

Sliding Rear Screen Door (if equipped)

The two center doors slide back behind the outer doors to provide walk-out access to the deck. These screen doors also feature a swing-out function to facilitate loading vehicles into the cargo bay.

To operate this feature:

1. Pull down on the spring-loaded handle to unlock the doors from the door frame. This allows them to swing out over the ramp door.
2. Once the vehicle is loaded, swing the doors back in place against the door frame.
3. Relatch the spring-loaded handle to secure the doors back in position.

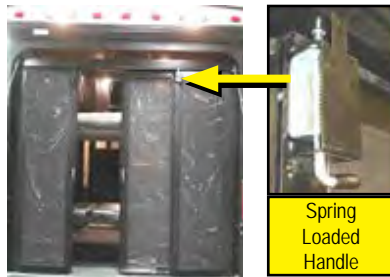

Sliding Screen Doors



PATIO DECK – SIDE (IF EQUIPPED)

⚠ WARNING ⚠ ⚠ CAUTION ⚠ (See page 35 and See page 36)

To set up the patio deck:

1. Unlatch the two keyed handles from the side of the RV (Fig 4).
2. Lower the patio deck until the cables on each side support it. Support cables are attached at the top of the door opening with a quick link (Fig 1) and to the deck with a safety pin (Fig 3). The patio deck is designed to be folded up with the support cables attached.

To set up the side rails:

1. Lift the (3) rails into their vertical positions. The rail supports drop into a slot on the deck-mounted brackets (Fig 5).
2. Attach the front railing to the side railing with a ball and socket connector (Fig 6).
3. Use the pivoting bracket on the deck's front gate to latch it over a metal pin (Fig 7).

The patio deck comes equipped with mesh end curtains that snap to the door jamb of the patio deck and to the framework of the railings. These curtains close off the gap between the railing and the door jamb (Fig 8).

Before returning the patio deck to the stored position:

1. Lift the rails to release them from the locking slots in the mounting brackets.
2. Lay the rails down on the deck.

Fig 9 shows the complete patio deck with the optional step ladder.

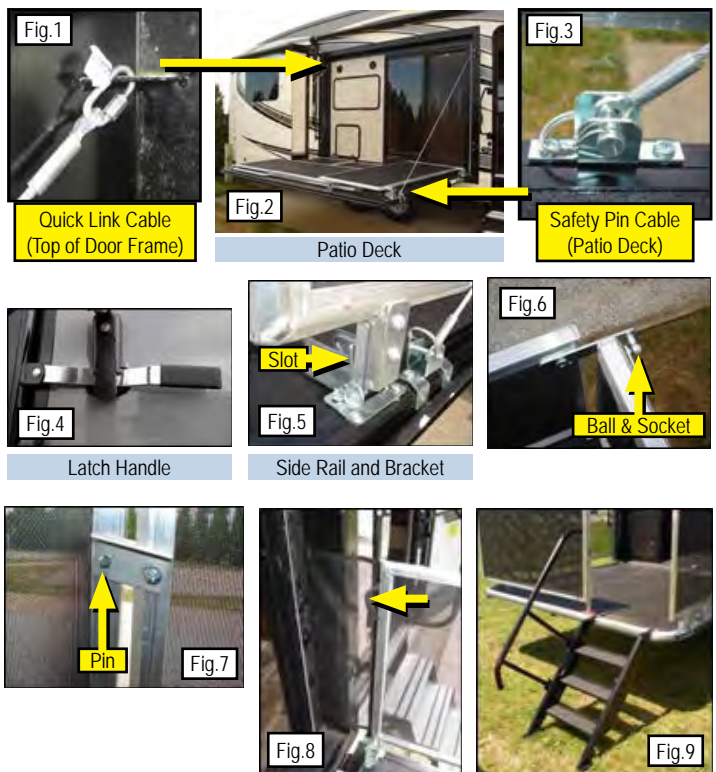

AWNINGS (IF EQUIPPED)

⚠ WARNING ⚠ **⚠ CAUTION ⚠** (See page 35 and See page 36)

Awning Care

Keep your awnings clean and in good condition to prevent costly repairs.

- Keep the awning fabric clean. Refer to the manufacturer's owner information for detailed cleaning instructions.
- Avoid using insecticides or other sprays near the awning fabric, as they can cause stains and affect water repellency.
- Protect the awning from adverse environmental conditions, corrosive agents, or harmful conditions.
- Prevent contact between the corner of the entry door and the awning fabric to avoid premature wear or tearing.
- Never close the awning for storage when wet to prevent mildew, discoloration, and stains. If necessary to roll up the awning temporarily while wet, allow it to dry completely before rolling it up again.
- Avoid accumulation of dirt, leaves, or debris on the awning to prevent abrasion, stains, and mildew growth.
- Clean awning hardware with a mild surface cleaner as needed. Do not use strong chemicals or abrasives.
- Apply silicone spray lubricant to moving parts on the fabric roller tube assembly and lubricate all pins and sliding surfaces of the arm assemblies as needed.
- Do not use abrasive or corrosive cleaners, mildew removers, or hard bristle brushes on the awning fabric.

Vinyl awning fabric is durable and water-resistant. Wrinkling is normal, especially after prolonged periods of stowage. Leave the awning open during warm weather to minimize wrinkling. A slight "travel line" where the door roller contacts the fabric is normal and does not affect its integrity.

To Clean The Fabric:

- Open the awning.
- Mix 1/4 cup soap with five gallons of fresh water. Always use a natural soap, not a detergent. The water should be cold to lukewarm, never more the 100° F.
- Liberally drench the fabric with cleaning solution.
- Close the awning and allow the solution to soak for five minutes.
- Open the awning and thoroughly hose off the top and bottom of the fabric with clean water. Repeat if necessary.
- Remove the solution COMPLETELY from the awning fabric.
- Make sure the fabric is dry before closing the awning. Air-dry only. Never apply heat to the fabric.

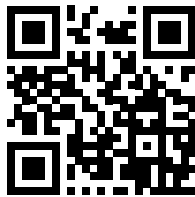

Power Awnings (if equipped)

NOTE

Electric awnings require connection to a 12-volt power source. Make sure you have sufficient power available before operating your awning (see "APPROXIMATE ELECTRICAL LOAD RATINGS" on page 48).

Your recreation vehicle may include one or more of the following options:

- Power window awnings
- Slide out awnings
- Power awning over entrance door

Power switches to operate the awnings are typically located in the control panel above the entrance door or accessible via the RV's touchscreen or JayCommand/TravelLINK phone app (if equipped).

Each power awning has its own control switch. Pressing and holding the switch will extend or retract the awning, and it should automatically stop when the switch is released.

NOTE

Do not overextend the awning. If the awning or awning skirt show signs of overextending, retract the awning until it is in the appropriate position.

Most power awnings allow you to adjust the pitch (slope) for water runoff and pooling. When adjusting the pitch, be mindful of entrance door and window clearances to avoid damaging or tearing the awning fabric.

Before retracting the awning, ensure there is no pooled water or debris on it.

When preparing to travel:

- Ensure the awning is completely retracted and secured.
- Turn off any light strips (if applicable).
- Disable all power sources to the awning.
- Test the awning prior to departure to ensure it does not extend unexpectedly.

Most power awnings have a manual override in case the awning fails to retract.

Refer to the manufacturer's user guide for detailed safety, operating, and troubleshooting information.

In Motion Detector (if equipped)

Some patio awnings are equipped with a motion detector. If the patio awning experiences extreme or excessive movement, it will automatically retract to the travel mode position.

For detailed safety and operating information, refer to the manufacturer's user guide.



TIRE PRESSURE (See page 25)

Failure to adhere to proper inflation guidelines may lead to tire failure. In certain circumstances, tire failure can result in loss of vehicle control or accidents causing property damage, bodily injury, and/or death.



TOWING (See page 19)

RV braking system rated for GVWR, not GCWR. Avoid traveling with waste in tanks to prevent towing issues. Turn off propane cylinder(s) during travel; refrigerators can maintain temperature for eight hours.

ELECTRIC BRAKES (See page 19)

Maintain brakes per axle OEM manual to avoid property damage, injury, or death. Consult with your dealer for assistance.

TOWING BEHIND YOUR RV (See page 20)

Without a factory-installed hitch receiver, towing or overloading may void warranty and lead to damage, towing issues, property damage, or personal injury. The RV's hitch receiver is for weight carrying only; do not use weight distribution bars, which can void the warranty and cause towing hazards, loss of control, or accidents resulting in serious injury or death.

STOWABLE ENTRANCE DOOR STEP (See page 20)

Maximum Weight Capacity: 500 lbs. Maintain hold of steps until fully lowered to ground. Adjust legs for proper leveling before use. Ensure both latches are engaged when steps are stored. Do not attempt to lift steps with door closed to avoid damage. Keep area clear of people and pets when rotating steps. Failure to adhere to guidelines may result in property damage or serious injury.

LEVELING SYSTEM (See page 22)

Never use auto leveling system to lift RV off ground, as it creates instability. Use leveling system only for leveling, not for servicing under RV. Park RV on level, solid ground; clear jack locations of debris. Ensure people and pets are away from RV during operation. Ensure battery is fully charged or RV is plugged into shore power before operation. Keep clear of fluid leaks, as hydraulic leaks can cause serious injuries.

Misuse of leveling system will void warranty. Failure to follow warnings may result in serious injury or death.

STABILIZERS (See page 22)

Do not use stabilizer jacks to level the RV; they are for support only while occupied. Stabilizer jacks are not designed to bear the weight of the RV. Fully retract stabilizer jacks before moving or towing the RV to prevent damage.

EMERGENCY TOWING (See page 24)

Never allow anyone under the RV while it is being lifted or towed.

WHEEL LUGS (See page 24)

Regularly check and tighten wheel lug nuts to prevent loosening during travel. Apply and maintain lug nuts at proper torque levels to prevent loose wheels and potential separation. Follow listed torque values for lug nut maintenance (see "Wheel Lug Nut Torque Values" on page 24.). Wheels must be mounted and torqued by a qualified technician using appropriate tools.

Failure to maintain proper torque may lead to tire and wheel separation while driving, causing property damage or personal injury.

WHEEL LUG NUT TORQUE VALUES (See page 24)

Before travel and after heavy braking, check lug nuts for torque. Check and re-torque lug nuts at 10 miles (16 Km), 25 miles (40 Km) and 50 miles (80 Km) and again periodically during travel. Failure to follow these instructions may result in wheel loss, an accident, or loss of control, resulting in death or serious injury.

**EMERGENCY STOPPING (See page 24)**

For personal safety, always stand off the road and out of the way of traffic.

TIRE PRESSURE (See page 25)

Regularly check tire pressure before each trip to extend tire life. Refer to the Federal Certification label for the correct pressure. Under-inflation can cause tire failure, leading to loss of control, injury, or damage. Special trailer (ST) tires have a maximum speed of 65 MPH; exceeding this limit may result in accidents. Exceeding the tire speed rating may result in tire failure, which could lead to an accident causing serious injury or death.

TIRE PRESSURE MONITOR SYSTEM (See page 25)

The TPMS system monitors tire pressure and temperature but may not warn of sudden critical tire damage or blowouts from external factors. Promptly react to any warnings and address issues. Tires can fail due to reasons other than low pressure, high temperature, or overloading. Watch for unusual noises, vibrations, uneven tread wear, or bulges on tires. If any of these symptoms occur, have tires inspected by a professional immediately.

CHANGING A TIRE (See page 26)

Do not use stabilizer jacks for supporting the RV or changing tires; they are for stabilization only. Avoid raising the RV using jacks placed under axles, springs, or attachment parts. Use only tires rated for RV use; avoid passenger tires. Passenger tires' load rating must be adjusted accordingly; they may not handle RV loads properly. Replace tires with the same size and specifications as indicated on the Federal Certification label. Failure to follow these guidelines may damage the vehicle and pose risks of serious injury or death.

SPARE TIRE CARRIER (See page 26)

DO NOT exceed the maximum load capacities of 100 lbs. for the hoist. DO NOT use air driven guns or impact wrenches to lift the spare tire to the travel position.

CARGO RAMP DOOR (See page 30)

Block all wheels before loading or unloading to prevent trailer movement, avoiding potential cargo ramp door shifting and tongue jack bending. Avoid sleeping in the cargo bay while internal combustion engines are in operation, stored, or transported in the RV. Only use the patio deck for its intended purpose to avoid voiding the warranty. Failure to follow these warnings may result in personal injury or property damage.

AUTOMATED RAMP DOOR SUPPORT CABLES (See page 30)

Detach rear patio cables from the ramp door before attempting to close it. Failure to remove cables may cause damage to the ramp door or the locking mechanism.

LOADING THE CARGO AREA (See page 31)

Do not exceed the GVWR; weigh the RV when loaded for travel to ensure safe weight. Do not travel with full grey/black holding tanks as it can affect handling. Do not exceed the maximum weight capacity of the cargo ramp. Ensure even weight distribution for optimal handling; secure heavy items to prevent shifting during travel. Motorized vehicles or equipment powered with flammable liquid can cause fire, explosion, or asphyxiation if stored or transported inside the RV. Do not ride or sleep in the storage area with vehicles present; close doors/windows in separation walls, run fuel out of engines, and avoid storing or dispensing fuel inside. Open ventilation systems when vehicles are present; avoid operating propane appliances, pilot lights, or electrical equipment. Failure to comply may result in an increased risk of fire, explosion, or asphyxiation leading to death or serious injury.

PATIO DECK - REAR (See page 31) PATIO DECK - SIDE (See page 32)

Do not exceed maximum patio weight capacity and maintain even weight distribution. Maximum capacity: 10 people, 1500 lbs. (680 Kg) with evenly distributed load when in patio position. Use stabilizers or leveling jacks when patio is deployed and in use. Failure to observe weight limit or misuse may result in property damage or serious personal injury.

AWNINGS (See page 33)

Awnings must be closed (and secured) while the RV is in transit. Avoid arm assemblies while operating awning to prevent injury or property damage. Failure to obey this caution could result in injury and/or property damage.

**TOWING (See page 19)**

Before towing your rv on the roadway: turn off the disconnect switch. Certain components inside the RV can unexpectedly activate which could result in personal injury or property damage.

BREAKAWAY SWITCH (See page 19)

NEVER use the breakaway switch and trailer brake system as a parking brake. Doing so would create a high amp draw on the battery and converter. This can cause damage to wiring, connectors and the breakaway switch.

ENTRANCE DOOR (See page 21)

Securely close and lock the entrance door while traveling to prevent accidental opening and unauthorized access..

TIRES (See page 25)

Check tire wear regularly; once a wear pattern sets in, it's hard to reverse even with corrections.

AWNINGS (See page 33)

Wind and rain can unpredictably damage awnings and RVs. Retract the awning if windy or rainy conditions are anticipated or when leaving the RV unattended for extended periods to avoid damage.

TIRE PRESSURE MONITOR SYSTEM (See page 25)

TPMS sensors do not move with the tires. Each sensor remains fixed at its designated tire position during tire rotation, ensuring accurate tire pressure readings on the touchscreen.

SETTING UP YOUR RECREATION VEHICLE (See page 27)

Never use stabilizer jacks to level the RV.

AUTOMATED RAMP DOOR (See page 31)

Before folding up the ramp door, remove patio support cables, safety pins, and quick links. Failure to do so may result in damage to the ramp door or door mechanism.

SIDE RAIL SETUP (See page 31) PATIO DECK - SIDE (See page 32)

Ensure all safety pins securing the side rails during transit are in place and secured with the safety clip when returning the cargo door to the stowed position. Failure to do so may cause damage to the rail and door.

SECTION 5: SLIDEOUT SYSTEMS



ELECTRIC SLIDE ROOM(S) (IF EQUIPPED)

⚠ CAUTION ⚠ ⚠ WARNING ⚠ (See page 39 and See page 39)

General Slideout Operation

- Ensure the auxiliary battery (customer-supplied) is fully charged and connected. Whenever possible, connect the RV to 120-volt AC power to enable the converter.
- The RV should be level, and the stabilizer jacks extended.
- Slideout switches are usually located inside the RV, either in the command center or on the wall.
- **To extend the slideout**, find the slideout control switch and press OUT/EXTEND, holding it until the slideout stops.
- **Retract the slideout** by pressing IN/RETRACT on the slideout control switch and holding until fully retracted.



Slideout Control Switch Example

Slideouts may also be operated through the JAYCOMMAND/ TravelLINK system (if equipped) via the touchscreen interface, mini interface, or smartphone app.

Check rubber seals on the slideout. Ensure corners of the black rubber seal are correctly set up to prevent water penetration. The top of the outside seal should overlap the side of the seal, and on the inside seal, the top seal should overlap the sides.

NOTE

For long-term storage it is recommend the slideout be retracted.

General Slideout Troubleshooting

For detailed troubleshooting, refer to the specific slideout system detail on the following page.

If The Slideout Fails To Move When The Switch Is Pressed:

1. Check the auxiliary battery for a full charge and secure wire connections.
2. Inspect the 12-volt fuse or circuit breaker.
3. Ensure there are no loose connections at the slideout motor.

If The Slideout Still Does Not Operate:

4. If extended, refer to the manual retraction section in the specific slideout system detail on the following page.
5. If retracted, leave it in that position.
6. Contact your dealer or customer service for repair assistance.

If The Slideout Extends Crookedly Or Only One Side Moves:

1. Contact your dealer or customer service for repair assistance.

SLIDE TYPES

Through Frame

Location: Both flush floor & above floor. Will be on the main floor of a 5th wheel, or any travel trailer where the slideout is at the floor level.

Characteristics: Ram arms can be found under the slideout.

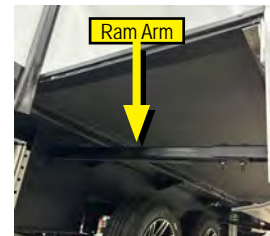

Manual Retract Procedure: On the opposite side of the coach from the slide there will be a 3/4" nut either on the frame rail (A) or on a motor accessed through a removable, screwed-down panel on the under-side (B). Using a ratchet or a tire iron, rotate the nut clockwise to retract the slide manually.



Lippert Slim Rack In Wall

Location: Found throughout the coach, used for main floor slideouts that are larger than 120".

Characteristics: There will be two small/thin tracks on each end wall. These tracks are only fastened at each end of the track and appear to "float" on the endwalls.



Manual Retract Procedure: Due to the motors being located in the wall and the size of the slide out, the Lippert Slim Rack system will need to be manually retracted by a professional. Please contact Customer Service, or your nearest Jayco Dealer for assistance.

SLIDEOUT SYSTEMS

Lippert - Schwintek In Wall

Location: Found throughout the coach whether it's a 5th wheel or travel trailer.

Characteristics: There will be two tracks on each end wall both fastened to the box. One track will be at the very bottom and the other will be toward the top.



Manual Retract Procedure: Locate the slideout system controller (C). Unplug motor 1 and motor 2 connectors at the bottom of the slideout controller. This releases the motor brakes for each motor. The slideout room can now be manually pushed in. Larger rooms may require several people to push or pull them. Keep both sides of the slideout even while pushing/pulling. When the room is completely in, plug both motor connectors back into the control module. This will apply the motor brakes for road travel.



Norco Exact Slide™ In Wall Cable Slide (5.5)

Location: Both flush floor & above floor. Can be throughout the coach on both 5th wheels and travel trailers.

Characteristics: There will be two cables on each endwall, one in both the lower and upper portion of the wall.

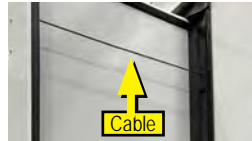

Manual Retract Procedure: The slide-out motors can be accessed behind the corners of the upper fascia on the interior of the slide. The flexible drill extension (D) provided in your Customer Information Packet is used to manually turn the motors. Retract the motors by rotating clockwise. Retract each side in small steps, going back and forth from side to side, until the slide is full retracted.



Norco Accu Slide™ Traditional Cable Slide (G4)

Location: Both flush floor & above floor: Can be throughout the coach on both 5th wheels (above floor only) and travel trailers (either setup).



Characteristics: The center of the interior fascia on the top of slide room will bow outward and protrude into the coach. Behind the curve in the fascia is the slide-out motor, gears, and cables.



View of Slide Motor System Behind Fascia

Manual Retract Procedure: You can access the slide out motor from above the fascia; but if there is not enough room above to allow access, the fascia will need to be removed. The top, bottom, center, and end trim pieces are attached to a header board with brad nails. The center trim piece is attached with glue. Gently pry the trim away to reveal screws that attach the header board to the slide-out roof. Remove the screws to take the fascia down. Use the flexible drill extension (D above) provided in your Customer Information Packet to turn the motor clockwise and retract the slide-out.



Motor Access Point

NOTE

Fascias that do not have center and end trim pieces, need only remove the bottom trim to access the header board screws.

**WARNING****ELECTRIC SLIDE ROOM (See page 37)**

- Before operating, ensure the interior slideout room path and the slideout room itself are clear of people and objects.
- Avoid the slide rails and gear assembly when the room is in motion to prevent the risk of pinching or catching on loose clothing, which could cause personal injury.
- Failure to adhere to these instructions could lead to serious injury or death.

**CAUTION****ELECTRIC SLIDE ROOM (See page 37)**

These guidelines should be followed when using your slideout room:

- Ensure the slideout is closed before connecting the unit to the tow vehicle.
- Level the recreational vehicle before operating the slideout room to avoid water leaks and other issues.
- Avoid placing excessive weight in the slideout room to prevent malfunction and damage.
- Release the switch immediately after the room is fully extended/retracted to avoid damage to the stop rod and bracket.

Do not use additional support jacks under the slideout, as improper use may damage the slideout room..

SECTION 6: ELECTRICAL



THE ELECTRICAL SYSTEM

The RV electrical system consists of two independent systems: one operates on 12-volt DC power and the other on 120-volt 60hz AC power. All installations adhere to industry standards applicable at the time of manufacture. As the electrical equipment and associated circuitry are specifically engineered for your RV, refrain from making unauthorized changes or adding fixed appliances, as these alterations may lead to hazardous conditions.

Service and modification of the electrical system should be carried out exclusively by qualified electrical technicians using approved materials, components, and methods that meet current safety and code requirements. For assistance, consult your dealer's service department.

For further details on the various components integrated into the RV electrical system, please refer to the information provided in your Customer Information Packet.

Electrical System Maintenance

⚠️ WARNING ⚠️ (See page 53)

Before working on the electrical system:

- Make sure the inverter/charger (if equipped) is turned "off" before disconnecting batteries.
- Disconnect the shore power cord.
- If equipped with a generator, turn off the generator and disable the automatic generator start functionality.
- Turn off the disconnect switch (if equipped).
- Turn off the 120-volt main circuit breaker.
- Disconnect the negative battery terminal from the battery.

12-VOLT DC SYSTEM

The majority of RV lighting is powered by 12-volt electricity. The 12-volt DC system functions under the following conditions:

- Power is provided by the tow vehicle alternator when the engine is running and the 7-way trailer plug is connected. This powers the RV's running lights, brake lights, turn signals, and brakes. Additionally, the 7-way trailer plug supplies a common ground and a 12-volt charge line to charge the auxiliary battery.
- The converter supplies interior 12-volt DC power when the power cord is plugged into campground power. It also charges the RV battery in most situations.
- The auxiliary battery powers various interior 12-volt components, including lighting fixtures, water pump, 12-volt motors, appliances, etc. It also powers the breakaway switch.

12-Volt Fuse Panel

⚠️ WARNING ⚠️ (See page 53)

The 12-volt fuse panel is labeled to indicate fuse sizes, positions and the components powered. Fuses are located in the load center.

Replacing a fuse

Before replacing a fuse, always turn off the electrical components protected by it.

1. Disconnect the shore power cord.
2. Turn "off" the inverter (if equipped).
3. Disconnect the negative battery terminal from the battery.
4. Remove the fuse panel cover to check fuses.
5. Pull the fuse straight out of the fuse block.
6. Insert a new fuse of the same specified voltage, amperage rating and type in the original location.



12-Volt DC/USB Outlet

⚠ WARNING ⚠ (See page 53)

Your recreational vehicle may contain one or more 12-volt DC/USB power outlets. When utilizing these outlets as a power source for an electric appliance, ensure the appliance operates on 12-volt DC power and consumes less than 60 watts (5 amps) of power.



LOAD CENTER

The Load Center houses 12-volt DC fuses and 120-volt AC circuit breakers for most electrical appliances and circuits in the RV. The 120-volt main breaker, which shuts off all 120-volt power to the RV, may also be situated in this panel. The location, appearance, and configuration of the load center may vary by model. Refer to the diagram inside the load center for specific fuse assignments.

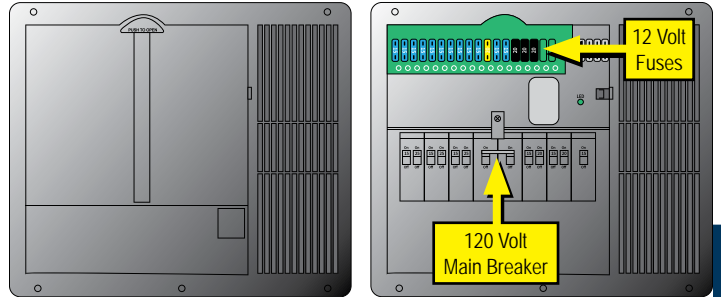

Load Center Panel Example Exterior

Load Center Panel Example Interior

Some models may feature separate small panels for breakers and fuses, usually located in close proximity to each other, typically in the bed platform area. The converter is typically mounted separately, often beneath the bed platform.

EXTERIOR LIGHTS (IF EQUIPPED)

Your recreational vehicle may be equipped with one or more of the following exterior lights.

- **Utility Light:** Mounted under the front cap, with the on/off switch typically located on the light itself.
- **Security Lights:** Up to three security lights mounted on either side of the unit, with switches usually found in the control center.
- **Fifth Wheel Docking Lights (if equipped):** Two docking lights on the front cap controlled by a switch located next to the fifth wheel hitch beneath the front cap.
- **LED Front Cap Strip Lights:** The switch for these lights may be inside a compartment near the front, on the exterior wall near the front, or next to the fifth wheel hitch (if applicable).
- **LED Awning Lights:** LED strip lights installed under each side awning, with controls located in the interior command center. The switch for rear side awning lights may be in the cargo bay area if equipped.
- **Ramp Lights:** Controlled from either the command center or the cargo bay area, above the rear door if equipped.

REPLACING LIGHTING

Replacement lighting must match the same type, voltage, and wattage as listed on the lamp fixture. Incorrectly sized replacements can overload lamp circuits and pose a fire hazard by causing fixture overheating.

ELECTRICAL

COMMAND CENTER

The command center, typically situated inside the entrance door or in the living area of the RV, contains switches and controls. Its applications, configurations, and components may vary by model.

Command Center Panel or Command Center Panel with Switch Modules

These panels may include the following items:

- Fuel gauge and hour meter with switches for fuel pump and fuel levels; fuel station (if equipped) on/off switch
- Lighted red pump and water heater switches (electric and LP gas)
- Generator start / stop switch; may include hour meter
- Tank heater switches
- Light switches for porch lights, exterior security lights, interior lights, awning LED lights, front cap LED accent lights, power entry step
- Cargo bed red lighted control switch
- Slideout control switches (press and hold to extend / retract)
- Awning control switches (press and hold to extend / retract)
- Systems monitor with LED indicators for tank levels and battery charge status
- Auto leveling control panel (for leveling the RV)
- Inverter panel (power switch with display)
- Power bunk bed lift control switch
- Speaker selector switch
- DSI water heater fault light

Fault/DSI Fault Light

The DSI (Direct Spark Ignition) Fault Light will illuminate if the gas water heater burner will not ignite.

Touch Dimmer Switch

In some models, there may be a touch dimmer switch located next to the Command Center panel

- Turn the ceiling lights ON or OFF: Tap the LED light on the dimmer.
- Dimmer: If lights are off, press on the LED light and lights will begin turning on gradually until fully lit. If lights are on, press on the LED light and lights gradually begin to turn off.

The dimmer has a memory and retains the light setting last used. When turned ON again, the lights revert to that setting.



Command Center Examples

GFCI RECEPTACLE

A ground fault current interrupter (GFCI) is integrated into the electrical system to reduce the risk of electric shock. Note that the GFCI does not provide protection against short circuits or circuit overloads.

Test all GFCI receptacles monthly.

- Push in the "TEST" button. The "RESET" button should pop, out indicating the GFCI receptacle has been tripped and interrupted 120-volt power.
- Push in the "RESET" button to restore 120-volt power.

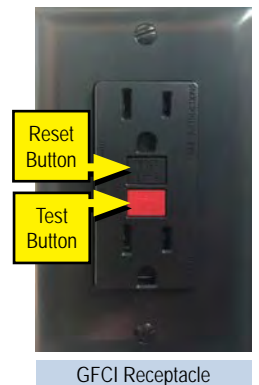

GFCI Receptacle

If the "RESET" button fails to restore 120-volt power and pops back out, contact your dealer for assistance.

NOTE

A "tripped" GFCI breaker indicates that abnormally high 120-volt current flow (a ground fault) was detected. All ground faults must be repaired before use of the recreational vehicle.

System Switches (Remote Controls)

The smart RV system comes equipped with multiple individual smart remote controls installed on the wall in each room. These remote controls utilize a 3-volt Lithium CR2032 coin cell battery.



Replacing the Battery:

- To access the battery on the back of the remote, remove the remote from the wall:
 - Pull the bottom of the remote away from the wall. You'll hear an audible snap as it releases from the clip.
 - Lift the remote upwards to unhook it at the top.
 - The remote will separate from the wall mount.
- To replace the remote on the wall:
 - Hook the top of the remote onto the top of the wall bracket.
 - Push the bottom of the remote back in place. You'll hear an audible snap as it attaches to the mount.

Tire Pressure Monitor System (TPMS)

⚠ WARNING ⚠ **⚠ CAUTION ⚠** (See page 54)

Your model may be equipped with a Tire Pressure Monitor System (TPMS). This system is monitored by sensors paired to the system through the touchscreen interface.



External TPMS Sensor

Features of TPMS:

Sensors: The TPMS system comes with sensors that are screwed onto the valve stem of each tire, either inside or outside.

Tire Position Programming: The sensors are programmed according to their tire position on the trailer, rather than to each individual tire.

QuickStart Guide

For your convenience, a QuickStart Guide is accessible from within the JayCommand/TravelLINK mobile phone app. This guide provides step-by-step instructions to assist you in setting up your RV at the campsite or preparing it for travel.

JAYCOMMAND PLUS BMPRO SYSTEM (IF EQUIPPED)

The BMPRO system, as detailed in the BMPRO Owner's Manual, offers comprehensive control of various RV functions via a wall-mounted RV tactile or touch screen control panel.

Features:

- Wi-Fi enabled for internet access and app updates (Models equipped with Touch Screen only)
- Smartphone, tablet, or smart device app available for download
- Bluetooth connectivity



Touch Screen Control Panel

Controlled Functions:

- Connected interior and exterior lights (note to tech writer – not all lights are connected)
- Slide-out rooms
- Power awnings
- Generator (if installed)
- HVAC thermostat (Models equipped with Touch Screen only)
- Tank type gas and electric water heaters (note to tech writer - tankless water heaters (standard for MC26) are not controlled)
- Tank levels (fresh water, black water, gray water)
- Battery levels
- Water pump



RV Tactile Control Panel

Activating the Touch Screen Equipped System:

- The system automatically boots up when RV 12-volt power is turned "on". Touch any location on the touch screen surface to wake up system if RV 12-volt power is "on" and the touch screen isn't illuminated. Note: You may need to manually turn "on" the touch screen (if it was previously manually turned "off") using the on/off button located on the left upper corner of the touch screen bezel.
- To re-boot the complete BmPro system:
- Navigate to the "Diagnostics" page on the touch screen or JayCommand Plus mobile app and select "Reset Node" located at top of page
- Allow nominal 30 seconds for reset process to finish
- System is now active and ready to use

Sidebar Control Buttons:

- Home Screen - Shows an overview of the key features of your RV: climate, lights, tanks, energy, and motors or quick start guide.
- Water Screen - Shows tank monitors (black, gray and fresh), water pump switch, gas and electric water heater switch (if RV equipped with tank type water heater), and switch for tank heaters (if RV equipped with tank heaters)
- Motors Screen - Shows controls for awnings, slide-outs, and towable model auto-leveling
- The app on your smart device automatically locks out the Motors screen on your device. You must swipe to unlock the screen in order to operate motors.
- Only one motor may be operated at a time.
- When a motor is in operation, motor control will be disabled on any other device running the App.
- Climate Screen - Shows a thermostat(s) and related controls used to operate RV heating, cooling, and cooling fan speed.

ELECTRICAL

- Heating and cooling is only controlled through BMPRO on touch screen equipped models. One or more small sensors are located on the RV interior walls. These sensors provide room temperature feedback to the BMPRO system allowing it to adjust room temperature according to climate selections made on the touch screen control panel.
- Lights Screen - Turn connected lights "on" and "off" along with ability to dim certain lights (tech writer - no slider on tactile panel)
- Energy Center Screen - Shows generator "on" and "off", AGS (auto generator start), battery levels, and fuel levels.
- Fans Screen - Shows bath fan on and off. (motorhomes only)

General Settings Screen –

General Settings may be accessed by pressing the Settings icon (gear icon) located at the lower left corner in the touch screen or app home screen.

- Bluetooth Connection: Check, activate, or deactivate the Bluetooth connection between the Node and the touch screen.
- Preferences: Set preferred temperature (Fahrenheit/Celsius) and tire pressure (kpa/psi) units of measure.
- Energy Center Settings: Access the AGS Energy settings.
- Battery Levels: Check the battery condition of any installed BMPRO Bluetooth wall switch or temperature sensor. Battery Levels screen is also used to individually pair and unpair Bluetooth wall switches and temperature sensors.
- User Manual: After establishing WIFI connectivity a digital version of the BMPRO owner's manual can be viewed on the system touch screen or BMPRO connected mobile device.
- On the HOME screen, press the Setting button (gear icon) located at the lower left corner in the touch screen or app home screen.
- Scroll down until you see USER MANUAL and tap to select.

Unpairing Bluetooth Mobile Devices

Up to four Bluetooth devices can be paired to the BMPRO system: This includes the touch screen control panel (if so equipped) plus up to 3 additional mobile devices (for a total of 4). The Node must be cleared of ALL previously paired mobile devices before additional or replacement mobile devices can be paired. A single mobile device cannot just be replaced with another mobile device. To clear the Node of all paired mobile devices:

On the Touch Screen Home Screen press the Setting button (gear icon) located at the lower left corner in the touch screen

- Press Bluetooth Connection.
- Press Unpair RV
- The Node is now cleared of all connected devices.

From the RV tactile control panel

- Press and hold the Bluetooth Pair button for 20 seconds.
- The Node is now cleared of all connected devices.

Pairing to the Node

Pairing the touch screen control panel to the node:

- From the BMPRO touch screen Home Screen press the Setting button (gear icon) located at the lower left corner in the touch screen
- Scroll down and select Bluetooth Connections
- Select Pair
- Follow the on-screen prompts to connect to the Node.
- The touch screen is now connected to the BMPRO System.

Pairing the RV Tactile control panel to the node:

- Pairing between the RV Tactile control panel and node automatically occurs when the RV Tactile control panel is network cable connected to the node

Pairing a mobile device to the node from the touch screen control panel:

- Launch the JayCommand Plus app on your mobile device
- From the BMPRO touch screen Home Screen press the Setting button (gear icon) located at the lower left corner in the touch screen
- Scroll down and select Pairing External Bluetooth Devices
- Select Pair located below the Pair iOS/Android Mobile App heading
- From your mobile device, follow the on-screen prompts to connect to the Node.
- Your mobile device is now connected to the BMPRO System.

120-VOLT AC ELECTRIC SYSTEM

When connected to 120-volt power, the following electrical components will operate: air conditioner(s), refrigerator, microwave oven, television(s), home theater system(s), water heater, washer, dryer, fireplace, electric stove, and appliances plugged into convenience receptacles. These components may cause a surge on the inverter.

Be cautious of overloading the recreational vehicle or campground electrical system, as this may cause a circuit breaker to trip. Operating multiple appliances simultaneously increases the load on your 120-volt electrical system. You can calculate the amperage rating of individual appliances by dividing the wattage consumed by the nominal design voltage (typically 120 volts for a 120-volt appliance). For example, 1200 watts divided by 120 volts equals 10 amps.

120-VOLT 30-AMP AC ELECTRIC SYSTEM (IF EQUIPPED)

⚠ WARNING ⚠ (See page 53)

The 30-amp 120-volt 60Hz AC electrical system is engineered to operate on one leg of 120-volt power with a maximum current flow of 30 amps.

It's crucial to avoid exposure to voltages higher or lower than the nominal 120 volts, as this can damage or shorten the service life of the electrical system and appliances. The 30-amp 120-volt 60Hz AC electrical system can be powered by the 120-volt 60Hz utilities found in campgrounds or by 120-volt 60Hz generator power.



30 Amp Receptacle

30-amp Power Cord

⚠ WARNING ⚠ (See page 53)

The 30-amp external utility power cord, commonly known as the "shore" power cord, is designed to mate and function correctly with 30-amp "shore" power receptacles available at most campgrounds. It is engineered to continuously carry the 30-amp current flow required to power each leg of the electrical system. Additionally, it establishes a critical ground connection between the vehicle electrical system and the campground shore power receptacle.

Calculating 30-amp Electrical Load

When connecting appliances to the electrical system, the usage of 120-volt power is limited to a total of 30 amps.

120-VOLT 50 AMP AC ELECTRIC SYSTEM (IF EQUIPPED)

⚠ WARNING ⚠ (See page 53)

The 50-amp 120-volt 60Hz AC electrical system can be powered by an external 120/240-volt 60Hz utility service, such as those commonly found in campgrounds, or by 120/240-volt 60Hz generator power. The entire system is engineered to operate on two legs of 120-volt power with a maximum current flow of 50 amps per leg.

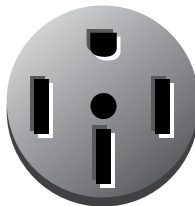

50 Amp Receptacle

It is crucial to avoid exposure to voltages higher or lower than the nominal 120 volts, as this can damage or shorten the service life of the electrical system and appliances.

50-amp Power Cord

⚠ WARNING ⚠ (See page 53)

The 50-amp external utility power cord, commonly known as the "shore" power cord, is designed to mate and function correctly with 50-amp "shore" power receptacles available at most campgrounds. It is engineered to continuously carry the 50-amp current flow required to power each leg of the electrical system. Additionally, it establishes a critical ground connection between the vehicle electrical system and the campground shore power receptacle.

Calculating 50-amp Electrical Load

When connecting appliances to the electrical system, the usage of 120-volt power is limited to 50 amps per electrical system leg, resulting in a total of 100 amps.

TESTING CAMPSITE POWER CONNECTION

⚠ WARNING ⚠ (See page 53)

Before plugging in the recreational vehicle shore power cord, always test the campsite 120-volt power receptacle(s) for proper functionality. Use a digital multimeter or a dedicated circuit analyzer for testing. Dedicated circuit analyzers plug directly into the campsite power receptacle and test for open neutral, open ground, and correct polarity. If the ground monitor indicates 'reverse polarity' or an 'open ground', DO NOT connect the power cord.

Inspect RV power cords for cuts, cracks, and worn insulation. If any of these symptoms are noticed, replace the power cord immediately.



CONNECTING POWER CORD(S)

To prevent power surges from damaging connected loads, follow these instructions when hooking up to the external power source:

1. Turn off the load center main 120-volt circuit breaker and the breaker at the external power source, if available.
2. Align the pins on the plug with the RV power connector and fully plug the RV end of the power cord into the RV power connector.
3. Rotate the power cord end locking mechanism clockwise by hand until the rotation stops (A). Avoid over-tightening.
4. Extend the entire length of the power cord from the RV electric connector to the external power source.
5. Fully plug the power cord into the appropriate (30-amp or 50-amp) receptacle at the power source, ensuring all power cord prongs are correctly aligned into the receptacle.
6. Turn on the load center main circuit breaker in the RV and the breaker at the external power source.



When ready to leave, reverse the power cord connection process. Grasp the plug to remove the power cord from the outlet; avoid unplugging it by pulling on the cord.



POWERED CORD REEL (IF EQUIPPED)

If your recreational vehicle is equipped with a powered cord reel, you can extend or retract the shore power cord using the extend/retract switch located in the same compartment near the cord reel. After extending the shore power cord, connect the cord to the campground shore power receptacle as noted above.

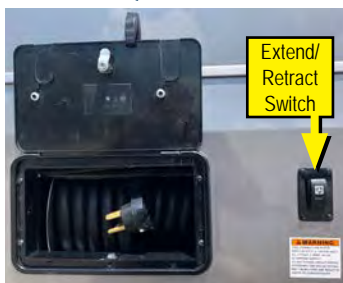

Powered Cord Reel Example

Refer to and follow all safety information found in the manufacturer's product manual included with your Customer Information Packet.

INVERTER (IF EQUIPPED)

A factory-installed inverter converts 12-volts DC to usable 120-volts AC, supplying continuous AC power to appliances plugged into it. It's essential to familiarize yourself with the inverter's function and operation, ensuring it's turned off when not in use.

If your recreational vehicle features a residential-style refrigerator, the inverter may power it by supplying the necessary 120-volts AC.

NOTE

The factory installed inverter is not intended for use, nor should be used, with any medical device(s). The inverter may, however, be used with some CPAP machines, depending on the CPAP model. Consult your CPAP machine's instruction manual before use.

Maintenance

There are no customer-serviceable parts inside the inverter case, and tampering will void the manufacturer's warranty. Keep the inverter cooling fins and fan clear of obstructions.

Command Center Switch (if equipped)

Your RV may include an inverter remote display on the Command Center switch panel. It features power and select buttons, status/display indicators, and a single-line digital alpha-numeric display. Here's a breakdown of its functions:

POWER Button: Press and hold for 1 second to turn the inverter on/off, indicated by a beep and LED display activation.

NOTE

When the inverter is in Inverter Mode, you can cycle through Battery Voltage, Inverter Power, inverter settings, and error codes. However, in Bypass Mode, you can cycle through Battery Voltage, inverter settings, and error codes. Inverter Power will not be available because the inverter is idle in Bypass Mode.

STATUS and DISPLAY Indicators:

- **Green LEDs:** Unit is plugged into shore power, displaying battery voltage in DC volts.
- **Amber (STATUS) and Green (DISPLAY) LEDs:** Inverter mode is active, showing battery voltage in DC volts (not connected to shore power).

- **Both Amber LEDs:** Inverter mode is active, displaying inverter power output in KW when pressing the SELECT button.
- **Flashing Amber (STATUS) and Off (DISPLAY) LEDs:** If the unit is in inverter mode and shore power is plugged in, it switches to bypass mode within 20 seconds, indicated by flashing LEDs.
- **Red (STATUS) and Off (DISPLAY) LEDs:** Displaying an error code (E01 through E12) indicates a fault in the inverter circuit, requiring attention and resulting in inverter shutdown.

NOTE

The power button is NOT a power disconnect switch and will not remove DC power from the inverter. Disconnect ALL power from the inverter before working on it.

Refer to the inverter manufacturer's manual in your Customer Information Packet for further instructions, error codes, changing settings, and safety information.

POWER CONVERTER

CAUTION (See page 54)

The power converter serves the purpose of converting 120-volt AC power to usable 12-volt DC power when the RV is connected to an external power source. Here are some key points to keep in mind regarding the power converter:

- **Overheating Protection:** The converter includes a built-in thermal breaker to shut it down in case of overheating. To avoid overheating, ensure that unnecessary 12-volt lights and motors are turned off, and keep the cooling fins and fan clear of obstructions.
- **Battery Selection:** Use only deep cycle batteries for RV applications. Car batteries are not suitable for RV use.
- **Battery Connection:** When using multiple batteries, they should be of the same brand and type to maintain charging efficiency.
- **Fuse Protection:** A reverse polarity fuse protects the converter in case of incorrect battery connection.
- **Fan Operation:** The fan speed is controlled by the load, starting at 3 to 6 amps DC draw and increasing with higher loads. It remains at maximum speed even with increased load until the load drops below 6 amps DC.
- **Testing Converter Output:** Before checking the converter output voltage, disconnect the battery cables at the battery. Ensure that the converter is plugged into an AC source (105-132 volts AC), and then check the output voltage at the battery with a voltmeter. A reading of 13.6 volts DC indicates proper functioning.
- **Troubleshooting:** If the converter output voltage is zero, check for open inline fuses, loose connections, or improper torques. If the issue persists, the converter may be faulty.

Modes of Operation

Absorption (Normal) Mode: Charging occurs at 13.6 volts DC.

Float Trickle Mode: Charging at 13.2 volts DC after reducing load on the system for approximately 44 hours.

Bulk Mode: Charging below 50% battery charge at voltages below 13.2 volts DC.

Inspection And Maintenance

Check the reverse polarity fuse(s) if the converter is not working. Avoid removing the converter case, as it contains no user-serviceable parts.

Charge Wizard (if equipped)

Some converters feature a Charge Wizard with different charging modes (Normal, Boost, Storage) indicated by LED flashes. The charge wizard automatically selects the appropriate mode for battery charging.

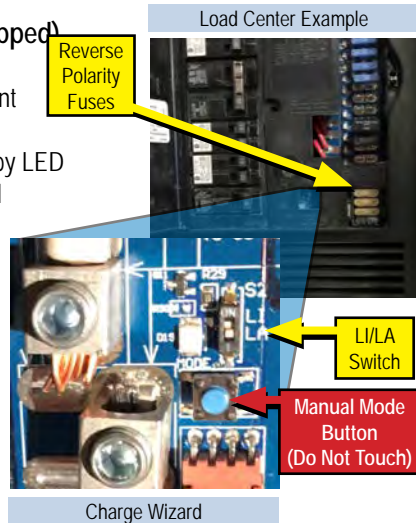

Manual Mode (not recommended): The manual mode button overrides the charge wizard and should be used cautiously.

Reverse Battery Protection: Reverse battery protection is provided by fuses located next to the charge wizard button. Ensure replacement fuses match the type and rating.

LI/LA Switch: The LI/LA switch sets the charge mode for Lithium (LI) or Liquid Acid (LA) batteries. Contact your dealer or customer service before changing this setting.

120-VOLT CIRCUIT BREAKERS

⚠ WARNING ⚠ **⚠ CAUTION ⚠** See page 53 and See page 54)

Here are some important points to remember about the 120-volt circuit breakers in your RV:

Purpose: The 120-volt AC circuit breakers in the load center protect all 120-volt wiring and components from circuit overloads and short circuits. If a circuit experiences an overload or short circuit, the circuit breaker will trip, cutting off the flow of electricity to that circuit.

Resetting Tripped Breakers: If a circuit breaker trips, turn off the appliance on that circuit and allow the breaker to cool down for a short period. Once cooled, reset the breaker by moving its lever from the "off" to the "on" position. If the breaker continues to trip or frequently trips, contact your dealer for diagnosis and repair.

Maintenance: Inspect the circuit breakers at the beginning of each camping season and replace them as needed. Test each breaker by turning it off and then back on. Circuit breakers are considered wearable parts and should be replaced as part of regular RV maintenance.

Labeling: Each 120-volt circuit breaker should have a label explaining its function. These labels are typically located on or near the load center or sub-panel and must remain permanently affixed to the RV for reference.



ELECTRICAL

Repair Assistance: When replacing circuit breakers or if you have any questions or concerns, it's recommended to contact your dealer for assistance. They can provide guidance and ensure proper installation and operation of the circuit breakers.

APPROXIMATE ELECTRICAL LOAD RATINGS

12-VOLT SYSTEM	
Exterior Entertainment Center	5-7 amps
Fan	1.5 amps
Furnace	12.0 amps
Generator Start	95.0 amps*
Illuminated Switch	.125 amp
Inverter	Variable
Leveling System	95.0 amps*
LP Detector	.125 amp
Light; LED	1.7 amps
Light; Vanity	4.2 amps
Lights; Aisle	1.0 amp
Lights; Baggage Compartment / Shower	1.4 amps
Lights; Decorative Wall / Map / Porch	1.5 amps
Lights; Double -12"	2.0 amps
Lights; Double -18"	2.5 amps
Power Awning	10.0 amps*
Power Vent	5.0 amps
Refrigerator	3.0 amps
Step Cover	10.0 amps*
TV Plate/Antenna Booster	1.0 amp
Water Heater	6.0 amps
Water Pump	7.0 amps

*Momentary Load

12-volts: Labeled watts divided by 12 = Power consumed in amps

120-VOLT SYSTEM	
Air Conditioner	18 amps
Coffee Maker	6-12 amps
Converter (each)	8 amps
DVD System	3 amps
Fireplace	15 amps
Hair Dryer or Curling Iron	10-14 amps
Microwave	15 amps
Refrigerator	6 amps
Satellite Receiver	2 amps
TV	2-4 amps
Vacuum Cleaner	8 amps
Washer/Dryer	12 amps
Water Heater	12 amps

120-volts: Labeled watts divided by 120 = Power consumed in amps



AUXILIARY BATTERY (CUSTOMER SUPPLIED)

⚠ WARNING ⚠ (See page 53)

Here are the key points regarding the auxiliary battery in your RV:

Usage: The auxiliary battery provides power to your RV's 12-volt DC loads when the power converter cannot meet the demand. It's typically used during dry camping or when the RV is not connected to shore power.

Battery Type: Your RV is designed to use a Group 27 or 31 deep cycle battery. If your RV came with a solar package, it may be equipped with a lithium battery instead.

Charging and Discharging: Before dry camping, ensure the auxiliary battery is fully charged. Monitor the battery voltage regularly using a volt-ohm meter. A fully charged lead acid or AGM battery reads 12.7 volts DC. Discharging the battery below certain levels can cause irreversible damage.

Estimated Usage: Consider the power consumption of your appliances to estimate battery usage. For example, running the furnace and refrigerator simultaneously may consume around 15 amps per hour. Plan your electrical usage accordingly to avoid draining the battery too quickly.

Installation and Maintenance: The auxiliary battery should be installed in parallel with the battery in your tow vehicle. Disconnect the negative cable from the auxiliary battery during storage to prevent discharge. Check the voltage monthly and recharge the battery as needed.

Replacement: When replacing the auxiliary battery, choose a Group 27 or Group 31 true deep cycle battery for extended run time. Ensure the positive and negative battery cables are correctly connected to avoid blowing the reverse polarity fuse(s).

Battery Isolator: Consider installing a battery isolator on your tow vehicle to control the distribution of energy to both the RV auxiliary battery and the tow vehicle battery.

DC to DC Power Converter: If installing lithium batteries, use a DC to DC power converter between the tow vehicle battery charge line and the trailer lithium battery(s) to prevent damage.

Disconnect Switch (if equipped): The fuse panel disconnect switch, located in an enclosed exterior compartment, shuts off 12-volt DC power to the main fuse panel and the interior of the vehicle. Rotate the dial or lever counter-clockwise to turn off the switch.

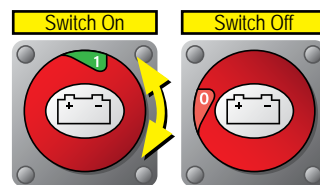

Rotating Dial Disconnect Example

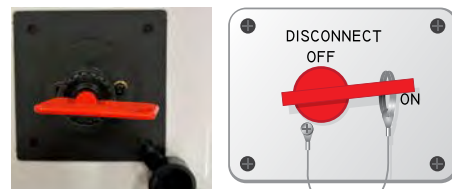

Lever Disconnect Examples



NOTE

A charged auxiliary battery must be installed before the RV is towed. The auxiliary battery powers the emergency braking system used to automatically activate trailer brakes in the event the trailer becomes disconnected from the tow vehicle.

ELECTRICAL

GENERATOR (IF EQUIPPED)

⚠ WARNING ⚠ **⚠ CAUTION ⚠** (See page 53 and See page 54)

The factory-installed generator in your RV provides 120-volt AC power for use when camping in areas without shore power. Here are some important points to consider before starting and maintaining your generator:

Safety Precautions:

- Ensure the carbon monoxide detector is functioning properly.
- Turn off air conditioners and all other appliances before starting the generator.
- Check for fuel, exhaust, and coolant leaks. If any leaks are detected, stop the generator immediately and have it repaired.

Starting the Generator:

- Press the operation control switch to start the generator. Preheating may take up to 15 seconds depending on the outside temperature.
- The hour meter will monitor usage time while the generator is running.



Stopping the Generator:

- Before stopping the generator, turn off air conditioners and large electrical loads.
- Allow the generator to run for 3 to 5 minutes to cool down before flipping the red start/stop switch to stop.

Maintenance:

- Perform regular maintenance such as oil changes as recommended by the generator manufacturer.
- All service work beyond normal maintenance should be done by a repair facility authorized by the generator OEM to avoid damage and safety hazards.

Exercising Your Generator:

- Regularly run your generator to keep it in good working order and prevent fuel varnishing.
- Lack of exercise can lead to moisture buildup and fuel system degradation.
- Run the generator at a minimum of 50 percent capacity (2000 watts or one air conditioner for a 4000-watt set) for two hours once every four weeks to prevent fuel varnishing and keep moving parts lubricated.

Traveling:

- While traveling, you can accomplish the exercise period by running the air conditioning or other appliances to meet the minimum load requirement.

Refer to the Manual:

- For more detailed information on generator safety, operation, and maintenance, refer to the generator owner's manual provided with your RV.

Following these guidelines will help ensure the proper operation and longevity of your RV generator



SOLAR PREP (IF EQUIPPED)

⚠ CAUTION ⚠ (See page 54)

Your recreational vehicle may be wired with a connection for the solar panel(s) and solar controller(s) to charge the battery. These come in 3 configurations:

1. An exterior port on the side wall, A-frame, or in the utility center that allows a suitcase style controller/solar panel combo to be plugged in. This port is wired to the battery via a 20-amp 12-volt circuit breaker.
2. A roof mounted port for a solar panel connection, and wiring to a location in an interior or basement wall where a solar controller may be installed. The capped off wiring in the wall for the controller then continues on to chassis ground and to the battery through a 30-amp 12-volt circuit breaker. A decal on the wall shows the wiring location, and a diagram of where to mount the controller.
3. A roof mounted port for a solar panel connection, and wiring to a location in the front basement compartment where a solar controller may be installed. The capped off wiring in the basement compartment then continues on to chassis ground and to the battery through a 30-amp 12-volt circuit breaker, and to a JAYCOMMAND/TravelLINK control panel used to manage the system. A decal on the basement wall panel shows the wiring location for the controller.



Contact your dealer for help with your solar installation. You can also find more info at WiredForSolar.com.

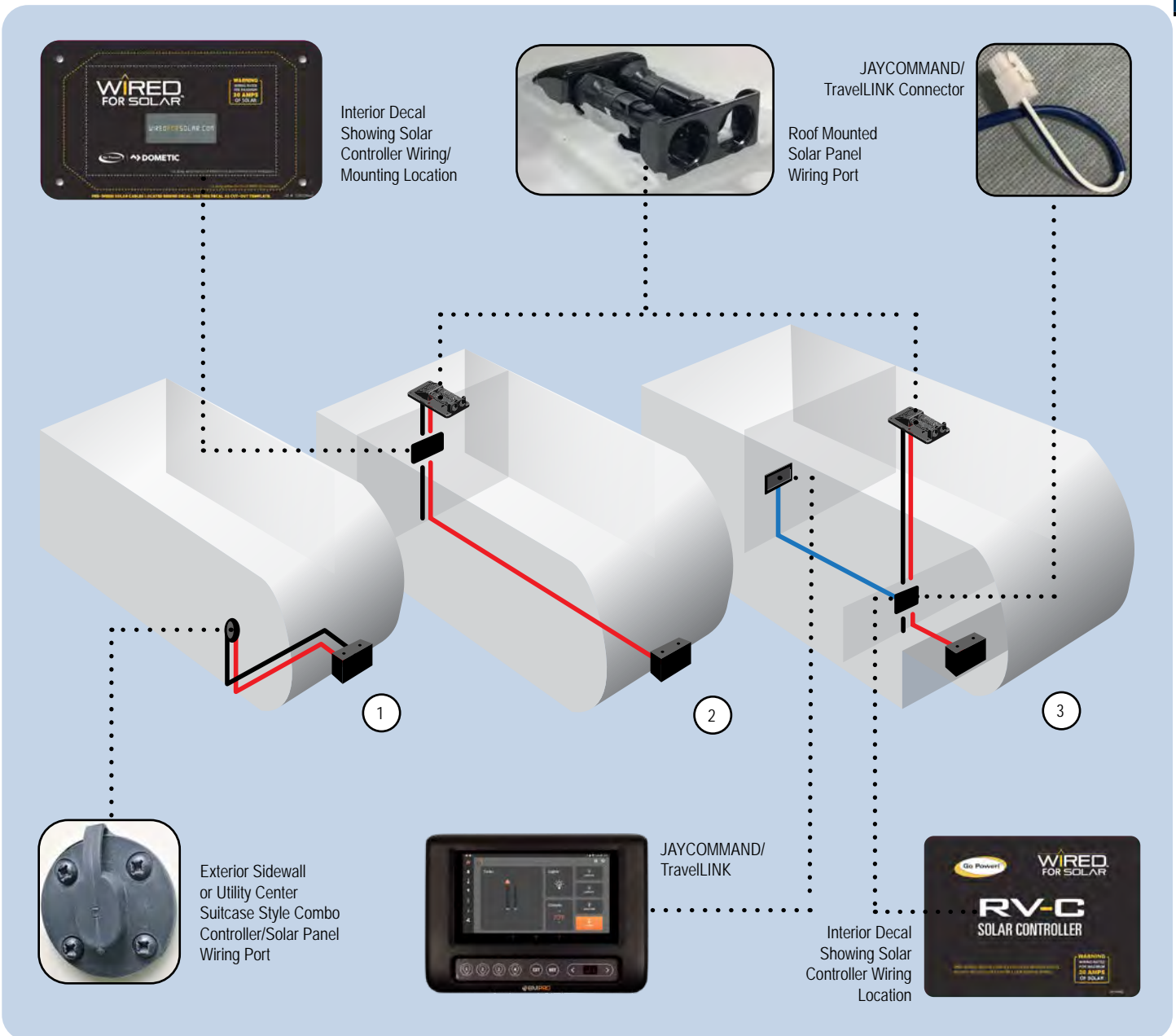

ELECTRICAL

SOLAR PACKAGE (IF EQUIPPED)

⚠ CAUTION ⚠ (See page 54)

Your recreational vehicle may be equipped with a factory installed solar panel kit that includes the solar panel(s) and solar controller(s). For care and operation, please refer to the manufacturer's instructions provided with your RV.

SOLAR PACKAGES	<i>OVERLANDER EXT</i>	<i>OVERLANDER 4</i>	<i>OVERLANDER 2</i> XTEND <small>SOLAR II</small>	<i>OVERLANDER 1</i> XTEND <small>SOLAR I</small>
NOMINAL 200W SOLAR PANELS	6	4	2	1
100AH LITHIUM SELF-HEATED BATTERIES	6	2	-	-
SOLAR CONTROLLER	100-AMP MPPT	60-AMP MPPT	30-AMP MPPT or 30-AMP DIGITAL PWM	30-AMP DIGITAL PWM
INVERTER	3000W SPLIT PHASE/ CHARGER	3000W SPLIT PHASE/ CHARGER	1800W RV-C or 1800W W/ DISPLAY	-
DC/DC POWER CONVERTER	X	X	-	-
SOFT START POWER SAVER 15K A/C W/ HEAT PUMP	LIVING ROOM	LIVING ROOM & BEDROOM	-	-
12-VOLT 13.5K AC	BEDROOM	-	-	-
BATTERY MONITOR	X	X	-	-
ENERGY MANAGEMENT SYSTEM	X	X	-	-
GENERATOR OPTION CAPABLE	X	5TH WHEEL ONLY	-	-
HEAVY GAUGE STEEL BATTERY ENCLOSURE	X	X	-	-

Solar Controller

Regulates voltage between the solar panels and the batteries. MPPT controllers are more efficient than standard controllers.

Inverter

Converts 12-volt DC power to 120-volt AC.

DC/DC Power Converter

Adjusts DC voltage between the tow vehicle and the RV batteries.

Soft Start/Power Save AC

Lowers AC startup and running power requirements.



12-volt AC

Air conditioning operates exclusively on 12V battery power.

Energy Management System

Monitors and manages RV power consumption to avoid nuisance circuit breaker tripping.

NOTE

When adding or changing solar panels or lithium batteries, the new items must be identical to the factory installed parts.

**ELECTRICAL SYSTEMS MAINTENANCE (See page 40)**

Use caution when using metal tools. If a tool contacts a battery terminal or metal connected to it, a short circuit could occur which could cause personal injury, explosion or fire.

12-VOLT FUSE PANEL (See page 40)

Replacement fuses must be of the same voltage, amperage rating and type. Never use a higher rated replacement fuse; doing so may cause a fire by overheating the RV wiring.

12-VOLT DC/USB OUTLET (See page 41)

Keep the protective dust cap on the 12-volt DC/USB outlet when not in use to prevent intrusion of foreign material and potential short circuit conditions.

TIRE PRESSURE MONITOR SYSTEM (See page 43)

The TPMS system monitors tire pressure and temperature but may not warn of sudden critical tire damage or blowouts from external factors. Promptly react to any warnings and address issues. Tires can fail due to reasons other than low pressure, high temperature, or overloading. Watch for unusual noises, vibrations, uneven tread wear, or bulges on tires. If any of these symptoms occur, have tires inspected by a professional immediately.

AUXILIARY BATTERY (See page 49)

Exercise caution when handling auxiliary batteries. Avoid storing items near battery terminals, keep sparks and flames away, use compatible power sources, ensure proper ventilation, wear protective gear, and avoid contact with battery electrolyte to prevent injury or damage.

GENERATOR (See page 50)

Running the generator indoors or in confined spaces poses a deadly risk of carbon monoxide poisoning. Always disable AGS (if equipped) before sleeping in the vehicle, parking in a garage, servicing, or fueling it.

TESTING THE CAMPSITE POWER CONNECTION (See page 45)**30 AMP POWER CORD & 50 AMP POWER CORD (See page 45)**

Before plugging in your RV's power cord, ensure proper polarity, grounding, and no signs of damage in the campsite receptacle. Avoid connecting to sources with reverse polarity, malfunctioning ground circuits, or signs of heat damage to prevent potential property damage or injury. Do not use adapters, remove grounding pins, or connect to ungrounded outlets, as this may pose safety risks. Never use extension cords or leave the power cord coiled, as it can overheat and cause equipment failure. It's the responsibility of the receptacle owner to maintain proper wiring and grounding to avoid hazards.

120-VOLT, 30-AMP AC ELECTRIC SYSTEM (See page 45)

Ensure the power cord is connected to a correctly wired 30-amp NEMA TT-30 RV receptacle, avoiding 240-volt AC connections. Only use 30-amp service to prevent damage. Note that circuit breakers and fuses may not fully protect the electrical system from power surges or voltage spikes.

120-VOLT, 50-AMP AC ELECTRIC SYSTEM (See page 45)

Ensure the power cord is connected to a properly wired 50-amp NEMA 14-50 RV receptacle, avoiding 240-volt AC connections. Use 50-amp service exclusively. Note that circuit breakers and fuses may not fully protect the electrical system from power surges or voltage spikes.

120 VOLT CIRCUIT BREAKERS (See page 47)

Replacement circuit breakers must be of the same voltage, amperage rating and type. Never use a higher rated replacement circuit breaker. Doing so may cause a fire by overheating the RV wiring.

**TIRE PRESSURE MONITOR SYSTEM (See page 43)**

TPMS sensors remain fixed to their respective tire positions during tire rotations to ensure accurate tire pressure readings on the touchscreen

POWER CONVERTER (See page 46)

Regularly check the fluid level of connected batteries, as all batteries will lose some fluid when continuously connected to a charging source (excluding "gel-cell" batteries).

120 VOLT CIRCUIT BREAKERS (See page 47)

Circuit breakers and fuses may not provide full protection against power surges or voltage spikes.

GENERATOR (See page 50)

To prevent overheating, avoid excessive cranking of the generator starter motor. Limit cranking to 20 seconds at a time, waiting at least two minutes between attempts. If unsuccessful after three tries, consult the generator manufacturer's manual. For optimal performance and engine longevity, especially in cold conditions, allow the generator engine to warm up for two minutes before activating 120-volt appliances

SOLAR PACKAGE & SOLAR PREP (See page 52)

Adding solar panels or equipment may impact the RV's carrying capacity. Consider vehicle weight ratings before installation. When connecting a tow vehicle to an RV with a lithium battery, ensure a DC/DC power converter is installed to prevent potential damage.

SECTION 7: FUEL & PROPANE SYSTEM



EXHAUST GAS FUMES

⚠ WARNING ⚠ (See page 59)

To prevent inhaling exhaust gases, follow these guidelines:

- Always turn off the tow vehicle engine, generator (if applicable), etc., while refueling.
- Avoid running the tow vehicle engine or generator (if applicable) in enclosed spaces longer than necessary.
- Keep windows closed while driving or running the generator to prevent exhaust gases from entering the RV.
- If you suspect exhaust fumes are entering the RV, address the issue promptly.
- Maintain a properly functioning ventilation system and active carbon monoxide detector.
- Ensure ventilation inlet grill(s) remain clear of obstructions for optimal operation.

PROPANE GAS SYSTEM

⚠ WARNING ⚠ (See page 59)

Propane gas is used for cooking, heating, hot water, and refrigeration in your RV. It's crucial to handle it safely due to its heavier-than-air nature, which can lead to pooling in low areas.

Your RV is equipped with a propane alarm (refer to **"COMBINATION CARBON MONOXIDE /PROPANE ALARM"** on page 11).

The system includes components like tanks, hoses, regulators, and piping. While the system undergoes testing, travel vibrations can loosen fittings. Have it checked after purchase and initial tank filling, and periodically thereafter, preferably every 5,000 miles or at least once a year, by a qualified propane service representative. Only hand-tighten LP gas system valves to avoid damaging the seals.



NOTE

All propane lines have been checked with air pressure at the time of manufacture. Dealers are required to recheck and adjust pressure before retail delivery.

Propane Gas Container

⚠ WARNING ⚠ (See page 59)

DOT propane cylinders used on RVs must be removed for filling and filled by weight at a qualified propane facility. Equipped with an overfill protection device (OPD), they must be oriented correctly, with markings indicating the top position. After filling, securely reinstall the cylinders, close the service valve, and use a dust cap or plug for transportation or storage.

Propane, compressed into a liquid, vaporizes when released for appliance use. It expands with temperature increase, requiring space inside the container for expansion during warmer weather. Keep the main shut-off valve closed except during system use or cylinder filling. Hand-tighten the valve to avoid damaging the interior seals. Leaks should be checked after initial filling and periodically thereafter. When filling a new cylinder, ensure it's purged of trapped air to enable proper appliance ignition.

LP Gas Container Overfill

Ensure your propane tank is never filled beyond its maximum safe level to prevent liquid propane from entering the system designed for vapor only, which could create a hazardous condition. The propane system is strictly for propane use; never connect natural gas to it. For maintenance, keep the exterior rust-free with periodic light reflective paint coats, as rust, scratches, or dents may compromise safety. Inspect the tank regularly, and any damaged or exposed-to-fire cylinders should not be refilled. Repairs should only be handled by certified technicians. DOT cylinders have a 12-year lifespan and must be recertified every five years thereafter for safe use. Inspect hoses, pipes, tubes, and fittings regularly for wear and replace with components of the same type and rating when necessary.

FUEL & PROPANE SYSTEM

NOTE

Tanks are to be installed, fueled and maintained in accordance to State and Local codes, rules, regulations or laws.

Two Stage Propane Regulators

⚠ WARNING ⚠ (See See page 59)

A propane regulator reduces pressure from propane containers to a safe level. It should be adjusted by a qualified technician using a calibrated manometer for optimal performance. If pressure is too high, it affects safety; if too low, appliances won't work properly. With a two-stage regulator, select the "supply" cylinder by turning the lever towards it, while keeping both cylinder valves open. A green indicator means full, orange signals empty. Switch to the "reserve" cylinder when one is empty. Refill the empty cylinder without interrupting gas flow.



Follow manufacturer's safety instructions in your Customer Information Packet.

PROPANE USE AND SAFETY

Propane is odorless, but an odorant is added for safety. If you smell propane inside the RV, follow the procedure on the propane system label. A low container might emit an onion or garlic-like odor, which can be mistaken for a leak. After refueling, this odor usually dissipates. If it persists, shut off the valve(s) and have the system inspected by a qualified professional.

Propane Leak Test

⚠ DANGER ⚠ (See page 58)

To check for propane leaks, use a soapy water solution, avoiding solutions with ammonia or chlorine as they can damage components. Apply the solution to fittings; bubbles indicate leaks. If a leak is found, shut off the propane system and contact a professional immediately.

Using the Propane System

Use the following steps for propane operation:

1. Close all burner valves and controls.
2. Slowly open the main valve in the propane tank to prevent propane "freeze-up."
3. Listen for any hissing noises indicating a leak; if heard, close the valve and seek professional assistance.
4. Light appliances according to manufacturer instructions in the owner's manual.
5. Keep propane container valves closed when not in use or during refueling.

Make sure that you read and fully understand ALL safety requirements for handling and operation of the propane system.

When using double cylinders on your RV, utilize only one at a time. Otherwise, propane will be drawn equally from both until both are empty. Using one cylinder until empty and then switching to the second allows for filling the empty cylinder at your convenience without running out of propane.

Cooking With Propane Gas

⚠ DANGER ⚠ ⚠ WARNING ⚠ (See page 58 & See page 59)

When cooking with propane gas in an RV, ensure proper ventilation to prevent asphyxiation due to limited oxygen supply. Consider the BTU ratings of your propane appliances and the availability of propane gas to calculate usage.

Calculating Propane Gas Usage

Each gallon of propane produces approximately 91,500 BTUs of heat energy, so divide the total appliance BTU ratings by this figure to estimate consumption.

NOTE

Unless there is heavy use of hot water, the on-demand water heater consumption of propane is minimal.

Propane Consumption Chart

The following chart provides average propane consumption information.

Appliance	Average BTU Consumption per Hour
On Demand Water Heater	60,000 (max setting)
Refrigerator	1,200 – 1,500
Furnace	35,000 – 40,000
Range/oven	7,100
Range, rear burner	6,500
Range, front burner	9,000
Outside Grill	10,000

Traveling with Propane

⚠ DANGER ⚠ (See page 58)

Make certain your propane tank is properly fastened in place, and your tank valves are closed during travel.



FUEL & PROPANE SYSTEM

USING THE FUEL STATION (IF EQUIPPED - SEISMIC ONLY)

Automotive Fuel Safety

⚠ DANGER ⚠ (See page 58)

Your RV may be equipped with a single factory-installed fuel tank that supplies fuel to the optional fuel station and/or optional generator. It is critical to understand the danger associated with fuel.



Fuel Station

Read, understand and follow all safety information in the fuel station manufacturer's manual before operating the fuel station. If you need further assistance, consult with your dealer or Customer Service.

Fuel Filler Cap

⚠ WARNING ⚠ (See page 59)

When removing the fuel filler cap, slowly turn it counterclockwise and wait for any "hiss" noise to cease before unscrewing it completely.

To securely close the fuel filler cap, turn it clockwise until you hear clicking sounds. Ensure to use only a cap specified for your fuel station when replacing the fuel tank filler cap.

Grounding Clip

Ensure to attach the grounding clip, which is connected to the fuel nozzle, to the component or vehicle being fueled. This action is essential for bonding/grounding it to the RV and preventing static charge buildup due to the flow of fuel.

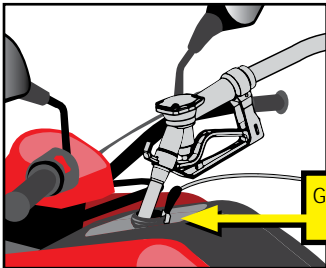

Grounding Clip Attached to Tank



Grounding Clip Inside Fuel Station

Fuel Pump Momentary Switch

⚠ WARNING ⚠ (See page 59)

The fuel pump momentary switch, found near the entrance door on the command center panel inside the RV, activates the fuel pump for 15 minutes before automatically stopping. To enable fuel dispensing, both this switch and the master/emergency disconnect switch must be turned on. Press the switch once to turn it on and twice to turn it off. When not in use, ensure both switches are turned off.



Fuel Tank(s) Fuel Selection (if equipped)

⚠ DANGER ⚠ **⚠ WARNING ⚠** (See page 58 and See page 59)

Ensure that the factory-installed fuel tank is filled with the recommended fuel type as per the generator or aftermarket equipment manufacturer's guidelines. These tanks are designed for unleaded gasoline with no more than 15% Ethanol blend. Do not use any other fuel blends or diesel fuel, as they can cause internal damage due to corrosion.

Fuel Gauge

Your RV is equipped with one of the following fuel gauges to monitor the amount of fuel available for use. The fuel gauge is typically located on the command center panel.

- **Command Center Panel:**
The fuel gauge is located on your command center panel along with your momentary switch.
- **BMPRO (If Equipped):**
If equipped, your Fuel Station fuel levels can be checked from your JAYCOMMAND/TravelINK (BMPRO) control panel under the energy section. For more details see "USING THE FUEL STATION (IF EQUIPPED - SEISMIC ONLY)" on page 57.



Command Center Panel Example



BMPRO Example

NOTE

To avoid running the battery down, always make sure that the fuel gauge selector switch is in the OFF position.

Dispensing Fuel

⚠ DANGER ⚠ (See page 58)

Be sure the fuel tank has fuel and free of debris prior to operating the fuel pump.

1. Attach the grounding clip to the item or vehicle being fueled.
2. Outside the RV at the fueling station, pull the master/emergency disconnect switch to the "ON" position.
3. Inside the RV, press the fuel pump momentary switch **one** time. Pushing this switch turns on the pump, and a timer which will automatically turn off the fuel pump after 15 minutes has elapsed (pressing this switch **two** times turns off the timer and the pump).
4. Outside the RV, insert the fuel nozzle into the receiving tank and squeeze the nozzle handle to dispense the fuel. Fueling should begin in 15 to 20 seconds.
5. When fueling is complete, release the nozzle handle to stop the flow of fuel. Replace the nozzle back into the fueling station storage box.
6. Turn off the master/emergency disconnect switch by pushing the knob in.
7. Disconnect the grounding clip.
8. Inside the RV, press the fuel pump switch next to the fuel gauge **two** times to cancel the timer and turn off the pump.

If the timer shuts off the pump before fueling is completed, turn on the fuel pump switch inside the RV. This will start another 15-minute cycle.

NOTE

Running the fuel dispensing pump for more than 5 minutes with the fuel nozzle closed will reduce the fuel pump motor life.



PROPANE LEAK TEST (See page 56)

Never use an open flame to test for a propane leak. Avoid using products containing ammonia or chlorine, as they can cause cracks in metal tubing and brass fittings when checking for leaks

TRAVELING WITH PROPANE (See page 56)

Before refueling motor fuel tanks or propane containers, ensure all pilot lights, appliances, and their igniters (refer to operating instructions) are turned off. Ignition of flammable vapors from these sources can lead to a fire or explosion. **Failure to comply could result in fire, death, or serious injury.**

DISPENSING FUEL (See page 55)

- **STATIC ELECTRIC SPARK EXPLOSION HAZARD:** Refrain from using cell phones or other electronic devices during fuel dispensing.
- Ensure proper grounding of the fuel pump. Attach the fuel nozzle grounding clip to the receiving component or vehicle.
- Maintain the pump according to the fuel pump manufacturer's operator manual. Perform necessary repairs before operation.
- **NO SMOKING:** Turn off all engines, fuel-burning appliances, and their igniters before dispensing fuel. Maintain a distance of at least 20 feet from any ignition source.
- **Failure to comply could lead to fire, death, or serious injury.**

COOKING WITH PROPANE GAS (See page 56)

Do not use cooking appliances for comfort heating. This can result in carbon monoxide poisoning, leading to death or serious injury.

FUEL TANK FUEL SELECTION (See page 56)

Ensure the RV is level from side to side and front to back before filling the fuel tank(s). This prevents potential overfilling. Do not overfill the factory-installed fuel tank(s). Once the pump shuts off automatically, do not attempt to add more fuel. Overfilling may cause fuel leakage and damage to fuel system components. Follow all safety information in this manual and the OEM operator's manual. Failure to comply could result in death or serious injury.

AUTOMOTIVE FUEL SAFETY (See page 56)

- Automotive fuels can cause serious injury or death if misused or mishandled. For further questions, consult your dealer or Customer Service.
- Always shut off the tow vehicle engine while refueling.
- Do not bring or store fuel or other flammable liquids inside the RV, as it may result in fire or explosion.
- Before refueling, extinguish all smoking materials and any open flames.
- Before refueling, always turn off all spark-producing appliances (i.e., water heaters, furnaces, etc.).
- Do not overfill the fuel tank(s). Overfilled tanks may lead to fuel leakage, spray, and fire.
- Fuel spills represent a serious fire hazard and should be cleaned up immediately.
- Never restart an engine or relight any pilot lights while raw fuel is present.
- The fuel tanks are specifically made for unleaded gasoline. Use clean, fresh unleaded fuel not containing a blend of more than 15% Ethanol.
- **Failure to comply could result in fire, death, or serious injury.**



WARNING



EXHAUST GAS FUMES (See page 55)

Avoid inhaling exhaust gases containing carbon monoxide, a potentially toxic and odorless gas. When in a recreational vehicle with a nearby tow vehicle engine or the generator running, there's a risk of exhaust fumes filtering back into the RV.

PROPANE GAS SYSTEM (See page 55)

Avoid storing propane cylinders inside the RV. Propane cylinders are equipped with safety devices to relieve excessive pressure by discharging propane into the atmosphere. Propane gas is highly flammable, can cause fire, explosion, or result in serious injury, including death.

PROPANE GAS CONTAINER (See page 55)

Transport and store DOT propane cylinders upright to ensure proper functioning of the pressure relief device; laying them on their side can be dangerous. Install the pigtail hose to prevent tension or pulling stress, and keep it away from sharp edges and compartment structures. Before entering a propane or fuel service station, extinguish all pilot lights, shut off gas to all appliances, and turn off any engines. Refrain from smoking or operating ignition sources while refueling. If you suspect overfilling of your propane container, seek assistance from your dealer or a qualified propane technician immediately; do not attempt to address it yourself.

FUEL FILLER CAP (See page 55)

Avoid using a substitute fuel fill cap, as it may lead to excessive fuel system pressure, potentially causing damage to the fuel station and improper operation during a collision. Exercise caution when opening the fuel filler cap quickly, especially in hot weather or when the tank(s) are nearly full, as fuel may spray out.

FUEL PUMP MOMENTARY SWITCH (See page 55)

If the fuel station equipment does not operate as expected, discontinue use and arrange for servicing before continued use.

PROPANE REGULATORS (See page 56)

Install regulators with the vent facing downward to ensure proper function. Ensure protective covers are in place on regulators not located in baggage compartments to prevent vent blockage and potential hazards like fire or explosion.

COOKING WITH PROPANE GAS (See page 56)

Do not allow gas to escape before lighting burner controls. Avoid using portable fuel burning equipment inside the RV, such as wood or charcoal grills/stoves.

FUEL TANK FUEL SELECTION (See page 56)

Working with fuel is hazardous and requires proper handling to prevent serious injury or death.

SECTION 8: PLUMBING SYSTEM



PLUMBING SYSTEM

There are two different water systems in your RV:

- **Fresh Water System:** consists of the fresh water holding tank, faucets and connections, water pump, water heater, tub/shower. On some models, it may also include the water purification system or outside shower assembly (if equipped).
- **Waste Water System:** consists of the grey (wastewater) and black (sewage) holding tanks, drains, and toilet.



Plumbing System Maintenance

- Check all lines and fittings for leaks before each trip or RV storage as part of your normal maintenance.
- Inspect all faucets, the water purification system (if equipped) and sink connections (including drain baskets or filters).
- At the end of every trip, drain any unused water from the fresh water system.

Look for labels affixed to the exterior of the RV sidewall indicating the locations of water system drains and fills. Some drain valves may be located inside the RV, corresponding to the exterior label locations.

Refer to the manufacturer's operating manual included in your Customer Information Packet for detailed operating, sanitizing, and winterizing information for each water system component.



MONITOR PANEL

Monitor panel locations may vary by model. Typical locations are on the command center panel near the door, on an interior wall, or on the exterior utility center. The monitor panel allows you to monitor the fresh water, grey water, black water and auxiliary battery levels. It operates on 12-volt DC power supplied by either the converter or auxiliary battery. No power is drawn from the battery unless a switch is pushed or turned ON. Fuses for the monitor panel are located in the load center.



Touch Screen Example

Some models may be equipped with a touch screen system that monitors tank levels electronically.

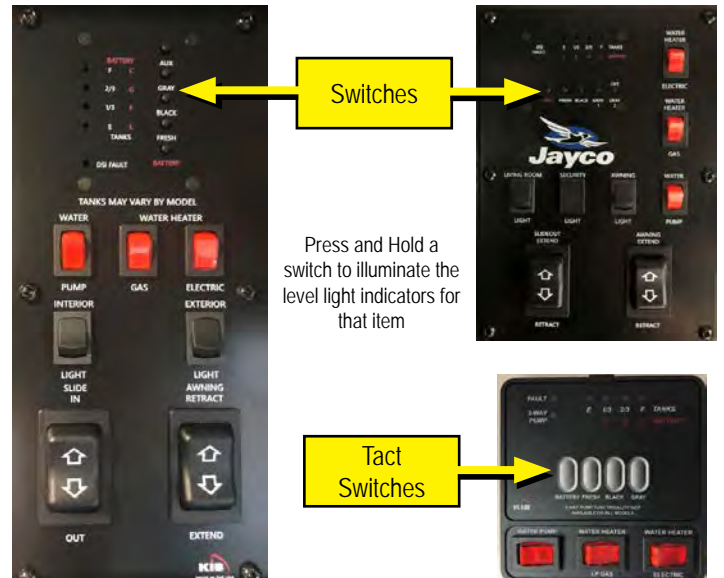

Command Center Examples

NOTE

If your RV has secondary black or gray tanks, there may be an additional tank monitor. It is typically labeled as a convenience center.

Operation

Press only one switch at a time. As you push either the FRESH, BLK GREY1 or GREY2 switch, one or more LED lights will illuminate indicating the content level for that tank.

Tank monitors on the touch screen have a constant readout. There are no buttons to push. Tank levels are displayed by percentage from 0% to FULL.

Water pump switch (if equipped)

The water pump switch may be located on the monitor panel, the utility center, or both. On some models, the water pump control may be on one of the selectable screens for the touch screen. When the water pump switch is ON (lit), the water pump will run until it reaches 45 lbs. of pressure. It will recycle when pressure drops. Turn the switch OFF when the water pump is not being used.

Water heater switch(s) (if equipped)

Water heater switches will be located on the monitor panel, the command center, or in the case of a touch screen system, on one of the selectable screens of the touch screen. Switches will light up when turned on. The "LP GAS" water heater switch (12V) enables propane operation of the water heater, and the "ELECTRIC switch (120V) enables electric operation of the water heater. Normally both switches should be turned on to provide the fastest hot water recovery time. The water heater can be operated in electric only or gas only modes by pressing each switch independently.

NOTE

If the RV is equipped with an on demand water heater, there will only be an LP Gas switch on the command center panel.

DSI FLT - Direct Spark Ignition Fault (if equipped)

This light will indicate a problem with the LP portion of the water heater. When the LP GAS switch is turned on, the light will blink quickly 3 times and the water heater will ignite. The light will then remain off. If the light comes on and stays on, it indicates the gas side of the water heater has not fired and there is a problem with the igniter.

NOTE

This light will not appear on touchscreens, RV remote controls, or on a Wi-Fi app. It only appears on the Command Center switch panel.

FRESH WATER SYSTEM

⚠ WARNING ⚠ (See page 77)

All water contains contaminant and mineral particles, which can cause odors. Untreated well water is a major source of water system odors. Periodic sanitization is needed to discourage the growth of bacteria and other organisms in the fresh water system. See "SANITIZING/WINTERIZING THE PLUMBING SYSTEM" on page 74 for more information.

Use a non-toxic drinking water hose dedicated solely to supplying the RV with fresh water. Prevent the openings of the water hose from touching the ground to reduce the chance of contamination.

Water Pressure Regulator (customer supplied)

⚠ CAUTION ⚠ (See page 78)

Excessive water pressure from the supply source, especially in mountain regions, can pose a risk to the RV's plumbing system. Water pressure regulators are available to protect the RV's plumbing system from high pressure. Consider using a water pressure regulator when using the fresh water inlet or black tank flush to prevent damage to the plumbing system.



Pressure Regulator Example

Fresh Water Holding Tank

⚠ CAUTION ⚠ (See page 78)

The fresh water holding tank is an essential component of your RV, providing water for camping when you're not connected to a pressurized water source. Depending on your RV model, there may be several methods available for filling the tank, as detailed in the "FRESH WATER CONNECTIONS" on page 62 or "UTILITY CENTERS" on page 65. Inside the tank, plastic overflow tubes allow excess water to flow out during filling or travel, a normal occurrence that might be noticed, especially when the RV is parked on an incline or during motion.

12-volt Water Pump

When you're not hooked up to city water, the 12-volt water pump ensures a steady water supply. This demand pump self-primers upon activation and continues to provide water until maximum pressure is reached. It's designed to automatically restart when water pressure drops, though some cycling may occur depending on water usage. However, it's important to note that the pump is engineered for intermittent use only; continuous or high-pressure operation may reduce its lifespan.

Maintenance

Routine maintenance of the water system is crucial. This includes periodic checks of the in-line strainer for debris accumulation and cleaning as necessary. Regular sanitizing and winterizing procedures are also recommended to maintain optimal performance and prevent premature pump failure. Additionally, it's essential to inspect all plumbing hardware and fittings for tightness to prevent leaks.

For additional information on the care and operation of the pump, read the safety and operating information in the pump manufacturer's owner's manual.

Water Pump Switch

Most water pump switches are equipped with illumination indicators, making it easy to know when the pump is activated. These switches can typically be found in various locations within the RV, such as the back of the unit, on the monitor panel, or integrated into a touchscreen system if available. When the water pump switch is turned on, the pump runs until it reaches a pressure of 45 lbs., indicated by a red light.



NOTE

The water pump switches should be in the OFF position when the RV is left unattended for any amount of time.

FRESH WATER CONNECTIONS

Fresh water connections in your RV serve as crucial points for accessing water from various sources. Depending on your RV model, you may have city water and gravity fill connections, each with specific procedures for use. For Utility Center configurations see "UTILITY CENTERS" on page 65.

NOTE

Avoid traveling with your fresh water tanks full. Instead fill your fresh water tanks, if needed, at or near your camping destination. If your campsite has a pressurized water source, there is no need to fill your fresh water tank.

Using the City Water Connection

- To use the city water connection, remove the connection cap and attach a non-toxic drinking water hose to the threaded inlet.
- Connect the other end of the hose to a pressurized fresh water source, ensuring it's dedicated solely to supplying water to the RV.
- To prevent strain on the threaded connector and hose, consider using a 90-degree elbow connector before attaching the hose.
- Turn on the water source and open cold water supply faucets to bleed air from the lines. Allow air pockets to escape before closing the faucets.
- The water heater fills first, followed by the supply lines and faucets. Ensure water heater bypass valves are open to allow water into the heater.
- Install an in-line water pressure regulator between the source and the city water connection to protect RV plumbing from high water pressure.
- Consider using an inline water filter to help avoid contaminants in the water.
- To disconnect, shut off the water source, remove the hose, and reinstall the connection cap.



City Water Connection Example



Pressure Regulator Example

NOTE

The City Water Connection inlet, when connected to a pressurized fresh water source, sends water through the water lines and fixtures without the use of the pump. For this reason the water pump should be turned off. The fresh water tank cannot be filled using the city water connection unless it is part of a utility center that has a valve configuration that allows it. For utility center valve configurations see "UTILITY CENTERS" on page 65.

Using the Gravity Fill

The gravity fill allows you to fill the fresh water tank from a container of fresh water when city water isn't available

- Close low point and fresh water tank drains.
- Remove the connection cap and insert a non-toxic drinking water hose (or funnel) into the gravity fill inlet, with the other end in a container of fresh water.
- Pour water into the gravity fill until the tank is full.
- Remove the hose and container, and replace the connection cap when the tank is full.



Gravity Water Fill Example

Fresh Water Connection Fill

Used only to fill the fresh water tank. Check your dial settings in the section covering "UTILITY CENTERS" on page 65.

Depending on the utility center being used this will either require a pressurized water source, or have the ability to siphon fill using the on board pump.

If no matching utility center is listed, this will use a pressurized source only.

When tank is full, turn off the water source, disconnect the hose. Fresh water tank level can be checked at the monitor panel. **Do not overfill the water tank.**

WATER PURIFICATION SYSTEM (IF EQUIPPED)

CAUTION (See page 78)

The water purification system, if equipped, relies on the canister filter as its primary component for filtering the entire water system. Here are the steps for maintaining and replacing the filter cartridge:

Flush the System: If the water supply has been inactive for some time, allow the water to flow for several minutes to flush the system.

Filter Replacement: Replace filters at the start of each camping season or if they've been exposed to contaminated water. Reduced water flow may indicate a clogged filter.

Storage: When not in use, store the water filter cartridge away from freezing temperatures to prevent damage. RV antifreeze can harm the cartridge. Filter locations vary by model, but they're usually found in a basement compartment behind the utility center (if equipped).

Transition from Winterization: Flush the system's canister water lines of any antifreeze before installing the filter cartridge for use.



To Replace Canister Filter Cartridge

1. **Prepare:** Turn off the water supply to the RV and disconnect the water line. Ensure the water pump is off. Place a drip pan below the filter housing to catch any spills.
2. **Remove Old Filter:** Use the provided filter wrench to unscrew the housing completely. Dump out any water and remove the old filter, disposing of it properly.
3. **Clean Housing:** Clean the inside of the filter housing with mild detergent, thoroughly rinsing and wiping it clean.
4. **Replace O-ring:** Remove the O-ring from the groove in the housing, wipe it clean, and coat it with petroleum jelly. Ensure it's properly seated in the groove.
5. **Install New Filter:** Insert the new filter cartridge into the housing.
6. **Reassemble:** Replace the canister housing, tightening it by hand. Turn on the water supply, then turn the pump on. Open a faucet to check for leaks, then turn the pump off.



Filter Wrench

Refer to the manufacturer's owner's manual and the label on the water filter cartridge for further information.

NOTE

There is no bypass feature on a canister style water filter. The water filter must be removed from the filter housing before sanitizing or winterizing the RV.

SPRAY PORT (IF EQUIPPED)

If your RV is equipped with a spray port on its exterior, it serves as a convenient tool for rinsing off items outside the RV.

Functionality: The spray port provides cold water only and doesn't have faucets to control the water flow. The water flow is regulated by the pump if you're dry camping or by city water if pressurized water is available.

Components: At the end of the coiled hose, there's a removable spray nozzle. Typically, the hose is stored under the bed when not in use.



Usage: To utilize the spray port, connect the end of the coiled hose into the fitting on the spray port. The fitting operates similarly to an air hose fitting, with a collar that needs to be pulled back to insert the hose. Once inserted, release the collar to lock the hose into place. With the water supply turned on, pull the trigger on the spray nozzle to adjust the water flow to your desired level.

The spray port should not be used as a potable water source.

TOILET

CAUTION (See page 78)

Your RV toilet is equipped with a flush pedal located near the base, either on the front or side. Here's how to use and maintain it:

Flush Operation:

- Pressing the flush pedal fully sprays water into the bowl and opens a ball valve at the bottom, allowing waste to flush directly into the black tank.
- Pressing the pedal halfway down doesn't open the ball valve, allowing you to fill the bowl with water. Keep at least 2 inches of water in the bowl to lubricate the ball valve seal and act as an additional vapor barrier to the black tank.



Pre-use Setup:

- Before using the toilet for the first time at a campsite, add water to the black tank to aid in breaking down future solids. Add no more than 5 gallons of water at this time.
- This is also an appropriate time to add RV black tank treatments following the supplier's directions for odor control and waste breakdown.

Cleaning and Maintenance:

- Regular cleaning is essential for maximum sanitation and operational efficiency.
- Use only septic-safe toilet paper to avoid clogs and maintain proper function.
- To inspect black tank levels visually, press the toilet foot pedal down fully and shine a flashlight through the waste gate opening. If the tank is near 3/4 full, it should be flushed. See "Dumping Procedure:" on page 71 for more information.



PLUMBING SYSTEM

DRAINING THE FRESH WATER SYSTEM

Draining the fresh water system is an essential step in RV maintenance. Here's a guide to help you through the process:

Locate Drain Valves:

- Fresh water tanks may have a valve near the tank itself.
- RVs with demand pressure pump systems typically have low-point drains attached to the water lines, usually located near the water tank.



Exterior Fresh Water Drain Example



Low Point Drain Example

Open Faucets and Valves:

- Turn off the water heater power (both electric and LP gas switches).
- Open all faucets, including the outside shower faucet if your RV is equipped with one.

Drain Fresh Water Tank:

- Depending on your RV model, you can drain the fresh water tank through:
- A white plastic drain attached to the exterior wall beneath the skirting.
- Pulling the white "T" handle on the fresh water holding tank (usually located near black and grey tank "T" handles).
- Opening the low point drains, which are typically labeled and located at the lowest point of the water lines.

Release Water Pressure:

- Turn ON the water pump if necessary.
- Operate the toilet flush lever until water stops flowing.

Prepare Water Heater:

- Set any bypass valves to the BYPASS configuration if your RV water heater has them. (refer to "Tank Versus On Demand Water Heaters" on page 74).
- Relieve water pressure from the water heater by lifting the T&P (temperature and pressure) relief valve lever BEFORE removing the water heater drain plug. Be cautious as the water may be hot if the heater was recently on.



T&P Relief Valve Example

Drain Water Heater:

- Once pressure is relieved, remove the water heater drain plug. Some liquid may remain in the tank even after draining.

Complete the Process:

- After draining the fresh water system, reverse the steps.
- Finally, empty the grey and black water holding tanks at an appropriate facility or as per local regulations.

By following these steps, you can effectively drain your RV's fresh water system, ensuring proper maintenance and functionality.



PLUMBING SYSTEM





UTILITY CENTERS

Your RV may have one of a number of Utility Centers installed. Below is a list of Utility Centers in use along with the handle settings and links to further information on use, winterizing, and sanitizing.

Nautilus P1

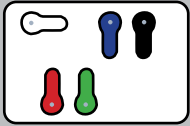
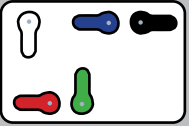
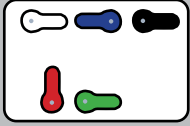
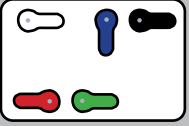
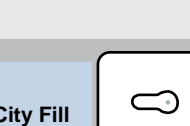
www.bandbolders.com/index.php/p1/

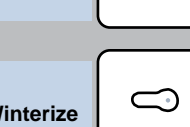





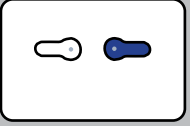

Dry Camping Water from tank via pump		City Water City inlet to fixtures		Winterize Siphon to fixtures via pump
				
PowerFill TANK City inlet to tank		Sanitize Siphon to tank via pump		
				

Nautilus P2

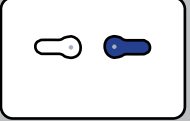
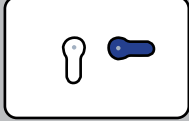
www.bandbolders.com/index.php/p2/

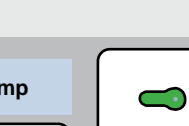



City Fill		Tank Fill		
				
Winterize		Dry Camping		
				

Nautilus P2.5

www.bandbolders.com/index.php/p2-5/

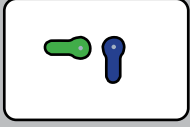
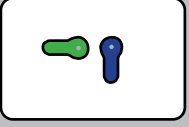
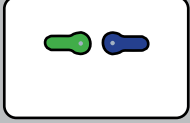
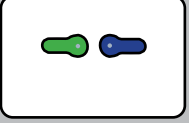
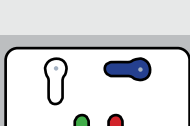
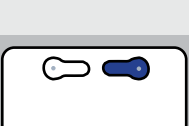

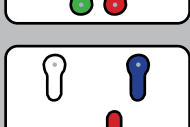
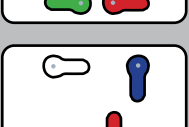

Sanitize		Dry Camp		Tank Fill
				
Winterize		City Water		
				

Nautilus P3

www.bandbolders.com/index.php/p3-2/

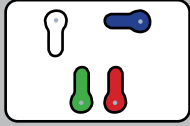
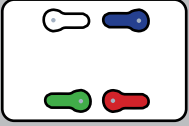
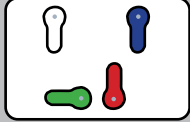
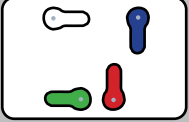
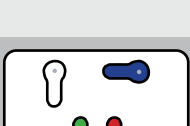
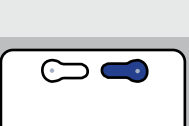

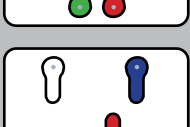
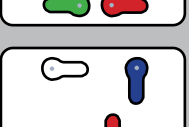



Dry Camping Water from tank via pump		City Water City inlet to fixtures		Winterize Siphon to fixtures via pump
				
PowerFill TANK City inlet to tank		Sanitize Siphon to tank via pump		
				

Nautilus P4

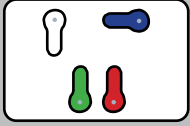
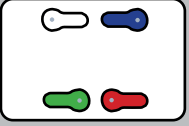
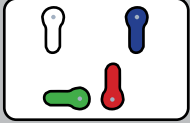
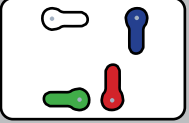
www.bandbolders.com/index.php/p4/





Dry Camping Water from tank via pump		City Water City inlet to fixtures		Winterize Siphon to fixtures via pump
				
PowerFill TANK City inlet to tank		Sanitize Siphon to tank via pump		

PLUMBING SYSTEM

Nautilus P4 - 3 Handle

www.bandbmolders.com/index.php/p4-3-handle/

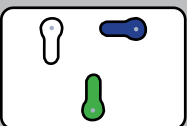
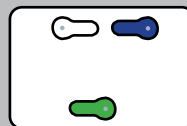

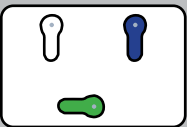
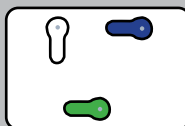
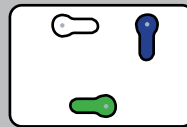

<p>Dry Camping Water from tank via pump</p>		<p>City Water City inlet to fixtures</p>		<p>Winterize Siphon to fixtures via pump</p>	
<p>PowerFill TANK City inlet to tank</p>				<p>Sanitize Siphon to tank via pump</p>	

Open Range Basic Utility Center

www.bandbmolders.com/index.php/product/docking-station-city-fill-tank-fill-tank-flush-no-coax-key-lock/



<p>Tank Fill</p>			<p>City Fill</p>	
<p>The lever controls whether the pressurized water entering the fresh water connection inlet provides water directly to the fixtures in the RV (City Fill), or simply fills the water tank (Tank Fill).</p>				

Open Range Fifth Wheel Utility Center

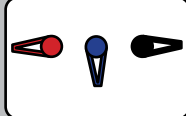
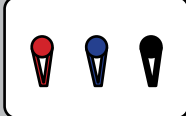
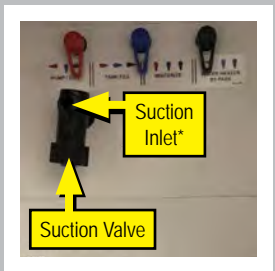
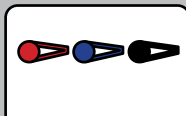
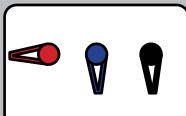

<p>Pump/City</p>			<p>Winterize</p>	
<p>Tank Fill</p>			<p>Water Heater Bypass</p>	

*Turning on the water pump not only draws water from the fresh water tank for use in the RV fixtures, but it also enables pumping into the water system via a hose attached to the suction inlet. This can be used for pulling in fresh water from a container using the "Tank Fill" settings (for when pressurized water is not available to fill from the fresh water connection), pulling RV antifreeze in the plumbing lines using the "Winterize" setting, or for pulling an anti-bacterial solution into the system for line and tank cleanings us the "Tank Fill" setting.

WATER HEATER

⚠ WARNING ⚠ (See page 77)

Your RV may feature either a tank water heater or an on-demand water heater. Some on-demand systems may include a small tank to maintain pre-heated water reserves.



Gas/Electric DSI Tank Water Heater System (if equipped)

Preparation: Ensure the water heater is filled with water before use. Opening both hot and cold water faucets when filling the fresh water tank helps remove air pockets from the heater.

Ignition: The water heater is equipped with a direct spark ignition (DSI) device, which automatically lights the burner. Do not attempt to manually light the burner.

Operating Instructions:

1. Turn ON the propane supply.
2. Activate electrical power to the water heater.
3. Set the switch to the "ON" position. If the burner fails to light, the system will make two additional attempts for ignition before lock-out.
4. Each ignition cycle includes a 15-second purge before the spark cycle in a three-try system.

Lock-Out Resolution: If lock-out occurs before ignition, switch the water heater control to OFF, wait five seconds, and then return it to the ON position to restart the ignition cycle.

Initial Start-Up: The first start-up may require multiple ignition cycles to purge all air from the propane lines.

Troubleshooting: If the burner fails to ignite, check the following:

- Verify that the switch is ON.
- Ensure the propane supply is not empty or turned OFF.
- Check if the reset button on the water heater ECO (Energy Cut-Off) is tripped.

Water Heater Switch (if equipped)

The "propane GAS" switch enables propane operation of the water heater, and the "ELECTRIC" switch enables electric operation.

NOTE

Water heaters in some models may only have an LP Gas water heater switch. These units do not offer electric water heating capabilities.

Water Heater Bypass (if equipped)

Your RV might feature a water heater bypass, either located directly at the water heater or on the utility center panel, depending on your model. For detailed information refer to the "UTILITY CENTERS" on page 65 or "SANITIZING/WINTERIZING THE PLUMBING SYSTEM" on page 74.

Odor From The Hot Water System

Sulfur Water Odor: Many water sources contain sulfur, which can result in an unpleasant odor in the hot water system. This odor, often referred to as "sulfur water," can be caused by chemical reactions or bacteria. While sulfur water is generally not harmful, it can be bothersome. Consult the water heater manufacturer's manual for

guidance on eliminating sulfur water odor. It's important to note that sulfur water odor is not a service issue.

High Elevation Deration

Elevation Considerations: Operating the water heater at high elevations may require derating. Improper derating can lead to issues such as insufficient oxygen for combustion, resulting in improper burner operation or even carbon monoxide production. Signs of inadequate derating may include pilot outage, burner lift-off, sooting, or decreased heating efficiency.

Professional Consultation: To ensure safe operation at high elevations, consult your dealer or a qualified service agency for proper derating of the water heater. Any necessary adjustments, such as changing the orifice for derating purposes, should be performed by trained professionals.

NOTE

Returning the RV to lower elevations (below 4500 feet), will require reversal of any adjustments made for high altitude operation or deration to ensure the proper functioning of the water heater.

Pressure and Temperature (P&T) Valve

⚠ WARNING ⚠ (See page 77)

The pressure and temperature (P&T) relief valve serves a critical function in your water heater system. It is designed to open if the temperature or pressure of the water exceeds safe levels. Here's what to know about its operation and maintenance:



Water Heater Pressure Valve

Normal Operation: If the temperature or pressure becomes too high, the relief valve will open, allowing water to drip out until the pressure is reduced to a safe level. This dripping is normal and does not necessarily indicate a faulty valve.

Maintaining Air Pocket: To reduce the frequency of the relief valve opening, it's helpful to maintain an air pocket at the top of the water heater tank. This air pocket naturally forms but diminishes over time with use. To replenish it:

1. Turn off the water heater and cold water supply.
2. Open a faucet in the RV.
3. Pull out the handle of the P&T valve to release water until it stops.
4. Release the handle - it should snap closed.
5. Close the faucet and turn on the cold water supply to refill the tank and develop the air pocket.

Maintenance Tips:

- Ensure the burner flame is blue, not yellow, indicating proper combustion.
- Periodically inspect the water heater vent for soot, which suggests incomplete combustion. Shut down the unit and seek professional assistance if soot is present.
- Check the vent for obstructions regularly to ensure proper ventilation.

PLUMBING SYSTEM

- Avoid terminating the vent inside enclosed areas to prevent the release of combustion byproducts into occupied spaces.

ON DEMAND WATER HEATER (IF EQUIPPED)

⚠ WARNING ⚠ ⚠ CAUTION ⚠ (See page 77 & See page 78)

The on-demand water heater offers several advantages over traditional storage tank models:

- Uses less LP gas, only heating water when needed.
- Provides unlimited hot water once lines are cleared.
- Automatically ignites burner when hot water is used.
- No need for anode rod or bypass valve for maintenance.
- Unaffected by high altitudes

Filling The Water Heater

1. Filling the Water Heater:
2. Close the water heater bypass lines if equipped.
3. Turn on the fresh water supply or switch on the water pump.
4. Fill the plumbing system by opening all faucets, showers, and the toilet to bleed air from the lines.
5. When water flows out of the faucets, the system is vented.
6. Close all fixtures

Operating Information

Open the exterior water heater panel to access the controls for turning the on-demand water heater on and off, and setting the water heater running mode.

Depending on the model, settings may include ECO mode, which keeps the system at a lower temperature and ramps up to full heat, and Basic/Comfort mode, which maintains full temperature, offering instant heated water.

For detailed instructions regarding operation, maintenance, draining, and safety guidelines, refer to the manufacturer's user guide in your Customer Information Packet, contact customer service or your dealer, or access documentation available on the manufacturer's website.

Furrion	support.lci1.com/waterheater
Girard	support.lci1.com/gp-llc-other-products
Suburban	suburbanrv.com/service-support
Truma	truma.net/water-systems

DRAINING AND WINTERIZATION

Frozen water within the water heater can cause significant damage, which is not covered under warranty. Therefore, it's essential to drain the water heater before storing your RV for an extended period, especially during the winter. For detailed information see "SANITIZING/WINTERIZING THE PLUMBING SYSTEM" on page 74.

FAUCETS

The bathroom, kitchen and outside shower faucets function similarly to home faucets. Initially, air may be present in plumbing lines, requiring bleeding for steady water flow.



BATHROOM TUB / SHOWER

⚠️ WARNING ⚠️ (See page 77)

Keep the holding tank capacities in mind when using the fresh water system. The used water will drain into the grey water holding tank.

- Ensure water heater is on and has warmed up before use.
- If dry camping, ensure 12-volt water pump is activated.

Unlike home setups, RVs lack a water pressure balance valve. **It is advisable not to use the fresh water system while someone is showering to maintain water pressure.**

The shower faucet might include a vacuum breaker, serving to prevent water from siphoning back or being retained in the hose. Note that the shower head lacks a complete shut-off valve; slight dripping in the OFF position is normal and not indicative of a leak.

OUTSIDE SHOWER (IF EQUIPPED)

Preparation: Before using the outside shower, ensure that the water heater is turned on and has had sufficient time to heat the water. If you are dry camping, activate the 12-volt water pump.

Accessing the Shower: Open the cover of the outside shower or utility center to access the shower assembly. Retrieve the handheld shower from its holder.

Adjusting Temperature: Turn on both the hot and cold faucet knobs and adjust them to achieve your desired water temperature. If applicable, activate the handheld shower by turning on the sprayer head attachment.

Stopping the Flow: To stop the water flow, close the hot and cold control knobs. Keep in mind that the lever on the shower head won't completely stop the flow to allow for proper drainage.

After Use: Once you have finished using the shower, return the handheld shower to its storage location. Any remaining water in the hose may drip or run out, which is normal. If you are dry camping, remember to turn off the water pump. If needed, detach the shower head for drainage and reassemble before storage. Ensure the hose isn't pinched during storage.

Temperature Consideration: Note that turning off the water with the shower head lever may cause a mixture of hot and cold water to flow through the outside shower faucet, potentially lowering the hot water temperature and giving the impression of a malfunctioning water heater.

Utility Center Variation: Some utility centers may utilize a quick connect hose for outdoor shower operation. For more information see "UTILITY CENTERS" on page 65.

BLACK/GREY WATER SYSTEM AND TANKS

Water from sinks and showers goes to the grey water tank, while toilet waste flows into the black water tank.

P-Traps (if equipped)

P-traps help prevent odors; adding water and deodorizing agents keeps them clean.



Waterless Traps (if equipped)

Waterless traps may replace P-traps; remove them before clearing clogs. The waterless trap can be unscrewed from the water lines. A label has been placed near the location of the waste valve that reads as follows:



**REMOVE WATERLESS TRAP BEFORE
USING MECHANICAL DRAIN CLEANING
DEVICES**

Sewer Hose Storage

Depending on your RV model there are different locations for sewer drain hose (customer supplied) storage.

- Exterior compartment marked "SEWER HOSE"
- Hollow square tube bumper. The bumper has removable plastic end caps, and the hose slides inside the hollow bumper.
- PVC storage tube mounted under the frame.

PLUMBING SYSTEM

Vents

Vent pipes release air from tanks; keep exterior vents clear to prevent buildup of gases.

Some models feature side vent systems, essential for proper airflow and ventilation. On these models this label will be next to the termination valve. This label should not be removed from your RV.

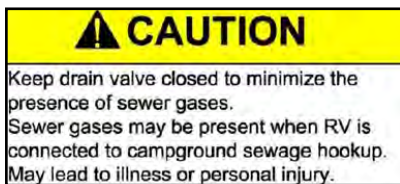

7.4.7.1.2

Black/Grey Water Holding Tanks

WARNING **CAUTION** (See page 77 & See page 78)

Pre-Travel Preparation:

- Dump grey and black water tanks before traveling to avoid exceeding weight limits and causing potential damage to suspension components.
- Remember that the weight of tank contents is not factored into the RV cargo carrying capacity.



Dry Camping Considerations:

- If unable to empty tanks immediately, reduce vehicle speed until reaching a dumping station.

Effective Drainage Tips:

- When connected to a campground sewer drain, keep the black tank valve closed until it's at least 3/4 full to ensure complete draining.
- Repeat the process as necessary for optimal waste removal.



Maintenance After Emptying:

- After dumping tanks, add the appropriate amount of black tank treatment to prevent odors and facilitate waste breakdown.
- Follow instructions on the treatment bottle or package for best results.
- Driving to a disposal site can help loosen any waste debris or solids from tank walls.



BLACK AND GREY TANK DRAINS

Look for labels on the RV exterior indicating grey and black tank drain locations (also known as dump valves). Depending on the RV model, there may be one or two valves:



Example of Tank Drain Located Underneath RV

Dumping Procedure:

1. Ensure the RV is level for easier drainage.
2. Remove the waste pipe cap and attach the sewer hose to the RV waste pipe.
3. Secure the other end of the sewer hose at the approved dump location.
4. Open the black tank dump valve and close it when the black water holding tank is empty.
5. Open the grey tank dump valve and close it when the grey holding tank is empty.
6. Ensure complete drainage from the hose into the sewer.
7. Remove and store the sewer hose, then reattach the waste pipe cap.

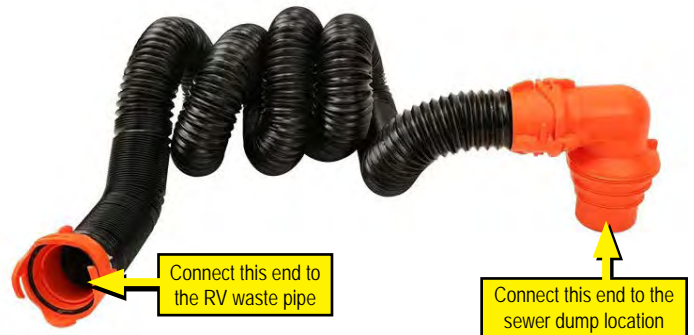

Sewer Hose Example

Finding Dump Stations:

- Check with your campsite in advance for available dumping stations.
- Dump sites can be found at campgrounds, state parks, truck stops, and some larger camping-focused retail stores.
- Websites like Sanidumps.com offer comprehensive RV dump station search tools.

Additional Equipment and Preparation:

Contact your RV dealer for assistance in the purchase and installation of a sewer hose or sewer hose extension (if needed).

Sewage (Black) Tank Preparation

Adding Water:

- Add up to 5 gallons of water to the black tank to aid in breaking down solids.
- Pour water into the tank or hold down the flush pedal on the toilet.

Using RV Black Tank Treatments:

- Add RV black tank treatments to prevent odors and break down waste.
- Follow the instructions provided by the treatment supplier.

Waste (Grey) Holding Tank Preparation

Odor Reduction:

- While no special preparation is required, consider adding a small quantity of chemicals like baking soda or an approved RV chemical to the grey tank to reduce food particle odors.

PLUMBING SYSTEM

MACERATOR PUMP SYSTEM (IF EQUIPPED)

⚠ WARNING ⚠ **⚠ CAUTION ⚠** (See page 77 & See page 78)

Your RV may be equipped with a macerator pump system used to discharge waste from the gray and black waste tank. The system includes a 1-1/2 inch diameter flexible hose that runs from the pump (under the RV) and is stored in an exterior storage compartment. The system, when powered on, can discharge waste (uphill if necessary) up to a distance of 150 feet.



Garden Hose Connection

Using The System:

1. Open the hose compartment and pull out the 1-1/2 inch flexible hose with the attached dump connector.
2. The dump connector includes two connections: a small removable cap for a 3/4 inch garden hose, and a larger 3-inch removable cap for the sewer outlet at the dump station.
3. Ensure the RV is level for easier drainage.
4. Attach the dump connector to the sewer outlet at the dump station or to a garden hose for dumping.
5. Open the black tank dump valve and turn the Macerator power switch ON to start pumping waste through the hose.
6. When the tank is empty, turn the macerator power switch OFF and close the black tank valve.
7. Open the gray tank dump valve and repeat the process.
8. After emptying both tanks, unhook the dump connector, rinse it out, and return the hose and connector to the storage compartment.



Dump Station Connection

Macerator Bypass Valve

The Macerator Bypass Valve is located underneath the external hose storage box. This bypass will allow gravity dumping of waste from tanks straight down to a 3-inch sewer hose connection under the trailer in the event there is a problem with the macerator motor. It also doubles as an emergency cutoff in case of issues with the flex hose or dump connector.

Operating Instructions:

1. Attach a 3-inch sewer hose to the main dump connector under the trailer and to a sewer outlet at a dump station.
2. Open the desired black/gray (manual) drain valves, one at a time (black then gray).
3. The bypass valve is normally open (handle pulled OUT). To bypass the macerator, push the bypass valve IN (turns off flow from the macerator pump), allowing waste to flow out of the dump connector under the trailer via gravity.

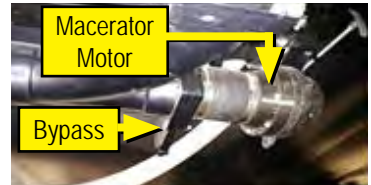
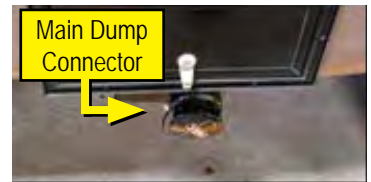

NOTE

The bypass valve is typically pointing back underneath the coach. Handle position is normally pulled OUT (bypass closed), designed to prevent accidental activation when the system is operating normally.

4. When finished, close the main dump gate valve under the trailer, along with the black/gray dump valves. Disconnect the sewer hose from the main dump connector and at the dump station.

Winterize The Macerator System

1. Ensure all waste tanks are empty.
2. Pour RV antifreeze into the toilet and down into the black water tank.
3. Make sure macerator bypass valve is pulled OUT. Turn the macerator pump ON.
4. Run the pump until antifreeze begins to discharge from the dump connector attached to the flex hose.

NOTE

Use a container (bucket) for capturing system fluid.

5. Turn the macerator pump OFF.
6. Drain the flex hose by holding it at a sloped angle to drain excess water and return the hose to the storage location.
7. As an added safety measure, push the Macerator Bypass valve IN to bypass the macerator and let it drain.
8. After draining make sure to pull the macerator bypass valve OUT again.

De-Winterize The Macerator System

Emptying the black tanks in the spring will flush antifreeze out of the macerator system.

BLACK TANK FLUSH (IF EQUIPPED)

⚠ WARNING ⚠ **⚠ CAUTION ⚠** (See page 77 & See page 78)

The black tank flush inlet is typically located either on the utility center panel (if equipped) labeled as "Tank Flush"; or on the side or back of the RV with a caution label next to it.

The black tank flush inlet is connected to a black water holding tank sprayer connection, allowing you to remove debris and prevent accumulation. A check valve is incorporated in the plumbing lines to prevent back flow. Flush the black water tank each time the grey and black holding tanks are dumped or as needed.



Exterior Black Tank Flush Inlet Example

NOTE

Utility center (if equipped) valve positions do not affect the tank flush function. It does not matter where they are positioned when operating the tank flush.

To help insure debris does not clog the tank sprayer orifices, use "TANK FLUSH" every time the waste holding tank is emptied.

1. Dump the black water tank (see "**BLACK AND GREY TANK DRAINS**" on page 71) and **LEAVE THE BLACK TANK DRAIN VALVE OPEN**.
2. Connect a garden hose from the water supply source to the black tank flush.
3. Turn the water source turned ON, flushing the black water holding tank until the water running out of the black tank drain valve is clear (not discolored or cloudy).
4. Turn off the water source, disconnect the garden hose, and close the black tank drain valve. Fasten the waste pipe cap back on the RV tank flush exit.

Winterize the Black Tank Flush

1. Flush and empty the blank tank prior to winterizing.
2. Connect a blowout plug to the Black Tank Flush inlet.
3. Colored valves have no effect on the black tank flush inlet.
4. Connect the air hose from a compressor to the blowout plug. Set the compressor to 30 PSI maximum.
5. Open the black tank drain gate valve and remove the waste pipe cap.



Blowout Plug Example

NOTE

If the RV has a macerator system, you may open the bypass valve for the macerator under the RV. This will allow the black tank to drain through the 4" sewer hose.

6. Blow air into the flush inlet for 30 to 60 seconds.
7. Disconnect the air hose, compressor and blowout plug.
8. Close the black tank drain gate valve, install the waste pipe cap, and close the macerator bypass valve (if applicable).

TANK HEATERS (IF EQUIPPED)

⚠ CAUTION ⚠ (See page 78)

Your recreational vehicle may be equipped with heaters for the fresh, gray, black water tanks. The larger tank heaters are 12VDC and attach directly to the tanks. The thermostat controlled tank heaters will cycle on at 44°F (7°C) and off at 64°F (18°C). All of the heaters are controlled by a single ON/OFF button that is typically located on the Command Center Panel or Firefly Touchscreen. The button lights up when 'ON' and controls the heater circuit

The Tank Heater Switch Should Be Turned On:

- When liquid is present in the holding tanks and the outside temperature is 35°F (2°C) or colder

The Tank Heater Switch Should Be Turned Off:

- When there is NO liquid present (tanks are empty).
- When dumping the black and gray holding tanks and the drain pipes.
- When fresh water tank and supply lines are empty or being drained for storage.
- When connected to city sewer and the gate valves are open.

NOTE

Leaving the drain valves open at all times while camping is never recommended, especially in cold weather use.

- When ambient temperatures rise and remain above freezing.

No maintenance is required, but periodically inspect for loose wires or damage. Refer to the manufacturer's user guide for detailed information.

PLUMBING SYSTEM

SANITIZING/WINTERIZING THE PLUMBING SYSTEM

Tank Versus On Demand Water Heaters

Tank water heaters have a bypass line to prevent bleach solutions and antifreeze from entering the tank during winterization and sanitization. The bypass line and associated valves are found at the water heater.

- **Normal Mode:** allows water to flow into the water heater. Both hot and cold bypass valve handles should point toward the water heater connections.
- **Bypass Mode:** diverts the flow of water around the water heater. Hot water bypass valve handle (C) should point inline with the hot water outlet line. Cold water bypass valve handle (B) should point inline with the cold water inlet line.

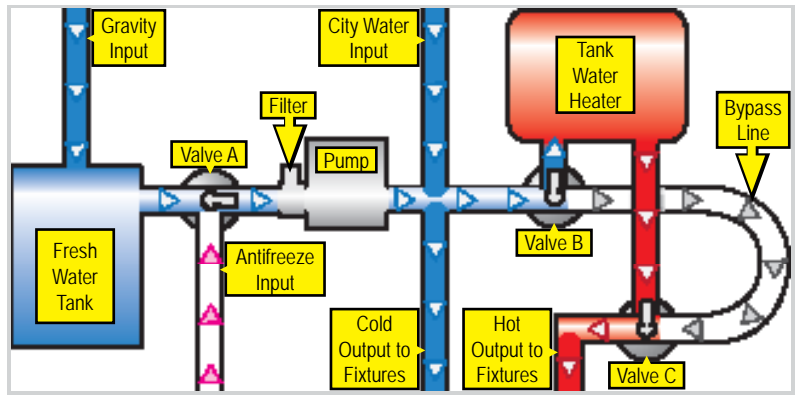

2-Valve Tank Water Heater Bypass - Valves Shown in Normal Mode

On-demand (tankless) water heater systems are not equipped with a dedicated bypass line, allowing sanitizer or antifreeze to flow through the unit during winterization. The water heater must remain powered off throughout this process to prevent damage. In RVs equipped with a Nautilus system, the winterization valve configuration is designed to bypass the water heater. However, to permit sanitizer or antifreeze to circulate through a tankless water heater, the Nautilus panel valves must be set to the "City Fill" position.

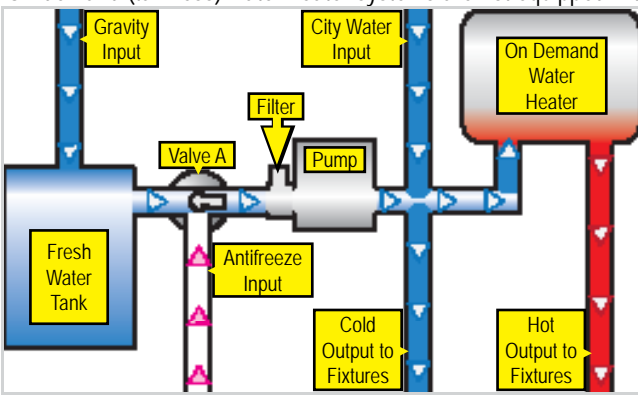

On Demand Water Heater System - Valve Shown in Normal Mode

Antifreeze Siphon

Both tank and on demand water heater systems have an additional line and valve (A) before the water pump to siphon antifreeze into the fresh water system, bypassing the fresh water tank. Turning Valve A towards the siphon line changes the input flow accordingly.

Utility Centers

For RVs equipped with Utility Centers, refer to "UTILITY CENTERS" on page 65 for specific instructions on sanitizing/winterizing.

Sanitizing the Plumbing System

When to Sanitize:

- When your RV is new.
- At the beginning and end of each season.
- When the water system becomes contaminated or every three months of use.

Preparing To Sanitize:

- Create a chlorine solution:
 - For a 50 ppm concentration: Mix 1/4 cup of household bleach with one gallon of water. Use one gallon of solution for every 15 gallons of tank capacity.
 - For a 100 ppm concentration: Mix 1/2 cup of household bleach with one gallon of water. Use one gallon of solution for every 15 gallons of tank capacity.
- Allow the solution to remain in the system for at least 4 hours (for 50 ppm) or 1 hour (for 100 ppm).

How To Sanitize:

1. Turn water heater OFF (both electric and LP gas switches if applicable).
2. Set the bypass valves to the **BYPASS** position for tank water heater systems.
3. Level the RV and drain the fresh water system.
4. Close the low point drain valves, the fresh water tank drain valve, and reinstall the water heater drain plug.
5. Remove the cartridge-type water filter, if present.
6. Pour the sanitizer solution into the fresh water tank through the gravity fill inlet.
7. Fill the tank with clean (potable) water until full.
8. Turn on the water pump and open all hot water faucets until water flows continuously and a chlorine smell is noticeable.
9. Close the hot water faucets and repeat the process with all cold water faucets, including outside shower faucets and toilet.
10. Turn off the water pump.
11. Allow the solution to remain in the tank and lines for the specified period.
12. Drain the chlorine solution from the fresh water system. Since the tank water heater was bypassed, there should be no sanitizer in the water heater tank.

NOTE

Fresh water tank sizes vary by model. Contact your dealer or customer service for your specific tank size.

Sanitize With Vinegar:

It is possible to sanitize the fresh water system with a 50/50 solution of white vinegar and water instead of a bleach solution. However, for the vinegar solution to work as a sanitizer, the temperature of the solution must be at least 130 degrees. Your RV water heater will not raise the temperature to this level, so the heated water will need to come from an outside source. Use caution when handling the heated solution if you decide to use this method.

A vinegar solution used to just clean and descale water systems does not need to be heated, and is safe to run through the system.

Rinse The System With Fresh Water:

1. Fill the fresh water tank full of clean (potable) water using the gravity fill inlet. Power to water heater should be OFF.
2. When the fresh water tank is full, turn the pump ON to send water through the lines. Tank water heater bypass valves should still be set to **BYPASS**.
3. Run water through all faucets (hot and cold, including outside shower) until chlorine smell is gone. For an on demand water heater, remove the drain plug and allow the water heater to rinse.
4. Turn OFF the faucets, outside shower, and pump. Re-install the water heater drain plug on your on demand water heater (if applicable).
5. Drain the fresh water system again.

If a chlorine taste lingers in the water, flush the water system with a solution consisting of one-quart vinegar to five gallons of clean water. Re-flush as necessary.

After Sanitizing:

- Set the Bypass valves to normal.
- Make sure all faucets are off including the external shower.
- Make sure the water heater drain plug is installed.
- Close the gravity fill inlet.
- Make sure the fresh water and low point drains are closed.
- Wash out the water filter housing and reinstall the water filter (if applicable).

Winterizing the Plumbing System

Preparing your RV for colder weather or storage is crucial to prevent damage from freezing temperatures. Failure to winterize your RV properly may lead to frozen water supply lines and damage to the water heater. It's recommended to winterize your RV at the end of the camping season or whenever it will be exposed to temperatures at or below 32°F (0°C). Repairs resulting from freezing are not covered by warranty.

The process of winterization may vary slightly depending on the plumbing configurations of different RV models. It's important to ensure that all appliances are properly winterized to prevent any potential damage. For detailed instructions tailored to your specific RV model, refer to the manufacturer's manual or contact your dealer.

If you decide to perform the winterization process yourself, it's crucial to thoroughly understand the steps involved before you begin. Take the time to read and comprehend the instructions provided. If you have any questions or uncertainties about the process, don't hesitate to consult your dealer for guidance.

Winterizing with Antifreeze Method (Preferred)

⚠ CAUTION ⚠ ⚠ WARNING ⚠ (See page 78 & See page 77)

Requires non-toxic RV antifreeze in the water lines and does not require any special tools. Use **ONLY RV ANTIFREEZE** in your fresh water system for freeze protection. No other product or commodity should be used.

NOTE

Antifreeze should never enter the tank water heater, RV water filter, refrigerator, refrigerator water filter, or fresh water tank.

1. Turn water heater OFF (both electric and LP gas switches if applicable).
2. For RVs equipped with a tank-type water heater, place the water heater bypass valves in the **BYPASS** position. For RVs equipped with a tankless water heater and Nautilus panel, configure the valves to the **City Fill** position to allow antifreeze to circulate through the tankless water heater.
3. Level the RV and drain the fresh water system.
4. Set the tank water heater bypass valves to **BYPASS**.
5. If the RV has a cartridge type water filter, remove it from the housing to prevent antifreeze from entering.
6. Close the fresh water tank and low point drains, and re-install the water heater drain plug if removed.
7. Open antifreeze siphon valve (A) at the water pump with the clear hose attached. Valve handle points toward the clear hose and insert the opposite end of the clear hose into a container of RV antifreeze solution.
8. Turn the water pump ON. Antifreeze will be drawn into the water lines. **In order to create a suction, all low point drains must be closed.**
9. Open the hot water faucets, including outside shower (if equipped) until RV antifreeze begins to flow continuously.
10. Close the hot water line faucets and outside shower and repeat with the cold water line faucets. Hold open the lever on the toilet until antifreeze runs into the bowl.

PLUMBING SYSTEM

When You Are Done Adding RV Antifreeze:

1. Turn the water pump OFF. Turn antifreeze siphon valve (A) to the normal position. Remove the clear hose from the container of RV antifreeze.
2. Pour 1 cup of RV antifreeze into each sink's drain P-trap.
3. To prevent staining, wipe the RV antifreeze out of the sinks, shower (or tub) and toilet using a soft, dry cloth.

In the spring after flushing antifreeze out of the water lines, wash out the water filter housing, and re-install the water filter (if applicable).

Air Pressure Method

⚠ WARNING ⚠ (See page 77)

This method uses compressed air to blow out any remaining water in the system after initially draining water using drain valves. Tools required would be an air compressor and a blowout plug.

1. Turn water heater OFF (both electric and LP gas switches if applicable). Allow the water in the water heater to cool before continuing.
2. Level the RV and drain the fresh water system.
3. Set the tank water heater bypass to **NORMAL** to allow air to flow through it. Remove the water heater drain plug once it's cooled. **DO NOT REMOVE THE DRAIN PLUG IF THE WATER HEATER IS HOT OR UNDER PRESSURE.** Release pressure using the pressure release valve and allow any stored water to cool.

4. Remove the water filter from its housing if applicable.
5. Run the water pump only until dry (typically 15 to 20 seconds) to avoid damaging the pump.
6. Open all faucets inside the RV and, if available, the shower faucets in the outside shower.
7. Attach a blowout plug to the city water inlet on the outside of the RV and connect the air hose to it. Set the compressor to 30 PSI.
8. Open the fresh water tank drain and blow air into the water lines through the blowout plug and city water inlet to remove all water from the lines. This process may take 5 to 10 minutes.
9. Pour one cup of RV antifreeze into each of the drain P-traps (sinks and bathtub).
10. Wipe the RV antifreeze from sinks, shower (or tub), and toilet with a soft, dry cloth to prevent staining.
11. After blowing out the water lines, remove the air hose and blowout plug from the city water inlet.



Blowout Plug Example

In the spring, turn off all faucets inside and outside, reinstall the water filter if applicable, reinstall the water heater drain plug, and close all low point and fresh water drains.





FRESH WATER SYSTEM (See page 61)

Do not consume water that is microbiologically unsafe or of uncertain quality.

The weight of holding tank contents is not factored into the RV's cargo carrying capacity. Traveling with full tanks may exceed tire ratings, RV GAWR, or GVWR, affecting vehicle handling.

WATER HEATER (See page 67)

Vent hydrogen gas buildup by running the hot water faucet before using electrical appliances.

Use only factory-approved parts; avoid aftermarket add-ons to prevent safety hazards and warranty avoidance.

If you smell propane gas, stop and follow propane system procedures before using the water heater.

P&T VALVE (See page 67)

Do not place a valve between the pressure and temperature (P&T) valve and the tank. Do not remove or plug the relief valve under any circumstances. Valve is not serviceable; if defective it must be replaced. Tampering with valve will result in scalding injury. Do not place a plug or reducing coupling on outlet part of valve. If you use a discharge line allow complete drainage for both valve and line.

Tampering with valve will void the warranty.

ON DEMAND WATER HEATER (See page 68)

Keep the area clear of combustible materials and gas vapors.

Switch off the appliance and gas supply if you detect gas, notice anything unusual, move the RV, approach a gas station, or enter a tunnel.

Only use LP gas (propane); avoid butane or mixtures with more than 10% butane.

Ensure the air inlet and exhaust gas outlet are unobstructed and keep objects away from the access door

BATHROOM TUB/SHOWER (See page 69)

Water temperatures over 125°F (49°C) can cause severe burns instantly. Use caution and test the water temperature before showering or washing.

BLACK/GREY WATER HOLDING TANKS (See page 70)

Never travel with full black or grey water holding tanks. This may affect your tow vehicle handling characteristics.

MACERATOR PUMP SYSTEM (See page 72)

Before using the macerator pump, ensure the external dump hose is correctly connected at both the RV and the dump station. The hose is pressurized, and misuse can result in injury or property damage. Any unauthorized use will void the warranty.

BLACK TANK FLUSH (See page 73)

Never utilize the same hose for filling your fresh (potable) water tank that is used for the black tank flush.

WINTERIZING WITH THE ANTIFREEZE METHOD (See page 75)

Automotive antifreeze (ethylene glycol) and windshield washer antifreeze (methanol) are toxic and potentially fatal if ingested. Never utilize these substances in your fresh water system.

AIR PRESSURE METHOD (See page 76)

Do not install a valve between the P&T valve and the tank. Never remove or block the relief valve under any condition. The valve cannot be repaired; if faulty, it must be substituted. Altering the valve can cause scalding. Avoid obstructing the valve outlet with a plug or reducing coupling. If using a discharge line, ensure both the valve and line drain entirely. Tampering with valve will void the warranty.



WATER PRESSURE REGULATOR (See page 61)

A water pressure regulator is recommended to safeguard the plumbing system from damage. For city water connections, a 45 lb. (315 KPa) rated regulator is advised to prevent potential harm.

FRESH WATER HOLDING TANK (See page 61)

Do not obstruct or modify the overflow tubes of the fresh water tank, as excessive water pressure during filling could damage the plumbing system. Avoid overfilling the tank to prevent pressure buildup, leaks, and potential warranty voidance. Always supervise the tank filling process and do not leave it unattended.

WATER PURIFICATION SYSTEM (See page 62)

To prevent damage, ensure water in the canister housing doesn't freeze. Remove the filter before winterizing with antifreeze or sanitizing with chlorine. Thoroughly flush the canister before reuse post-winterization or sanitization. Replace the filter every 6-12 months for optimal performance. Avoid using carbon cartridges where water safety is uncertain. Maintain a maximum operating pressure of 125 psi (8.75 bar) and a water temperature below 125°F (52°C).

TOILET (See page 63)

To avoid blockages, adhere to the toilet manufacturer's guidelines after emptying the black water tank. Use only RV-grade single-ply toilet paper to prevent clogs; avoid flushing paper towels, diapers, or sanitary products. Refrain from using undiluted chlorine or caustic chemicals like bleach, as they harm toilet seals and dump valves.

ON DEMAND WATER HEATER (See page 68)

Prior to filling water into appliances and water transport parts, ensure the installation area is adequately heated to prevent freezing, as water in pipes, faucets, and appliances could lead to significant damage if frozen.

BLACK/GREY WATER HOLDING TANKS (See page 70)

It's crucial to never leave the black tank drain open continuously when connected to the campground sewer system. Doing so can lead to potential blockages in the tank as liquid drains out. Keeping the drain closed prevents debris accumulation. Avoid adding automotive antifreeze or caustic chemicals like laundry detergents to the holding tanks, as they may cause damage to the plumbing system components.

MACERATOR PUMP SYSTEM (See page 72)

When winterizing the RV, it's essential to add antifreeze to the macerator system as water can accumulate in the flexible hose and dump connector.

BLACK TANK FLUSH (See page 73)

Always ensure that the black tank drain valve is OPEN when there is a hose (water supply) connected to the black tank flush. Do not leave any hose (water supply) connected to the black tank flush when it is not in use.

TANK HEATERS (See page 73)

To ensure the 120VAC tank heaters function, the RV must be connected to shore power or powered by a generator. Without this power source, only the +12VDC heaters will operate, increasing the risk of tank freezing. Note that the red light on the command center tank switch indicates that the heater circuit is ON, not necessarily that ALL heaters are operational.

WINTERIZING WITH THE ANTIFREEZE METHOD (See page 75)

Water can accumulate in the flexible hose and dump connector of the macerator system. When winterizing the RV, antifreeze must be added to the macerator system.

SECTION 9: HEATING & COOLING



AIR CONDITIONER

RV air conditioners gradually cool the interior air, and several measures can expedite this process:

- Park the RV in a shaded area.
- Start the AC promptly after setting up the RV.
- Close window shades/curtains to block sunlight heat.
- Keep doors and windows closed whenever possible.
- Ensure sufficient power is available before operating the air conditioner.

NOTE

In warm and humid regions, running the air conditioning unit on high can enhance airflow and mitigate moisture condensation on the coils.

It's crucial to use the return air filter when operating the air conditioner to prevent lint and dirt accumulation on the cooling coil, which can lead to reduced air volume, potential equipment damage, and costly cleaning. For instructions on air conditioner use and maintenance, refer to the manufacturer's user guide included in your Customer Information Packet.

Roof Mount (if equipped)

Roof mount air conditioners may be ducted (connected to other vents in the roof interior) or non-ducted. On ducted units, close main AC unit air vents to enhance air circulation through ducts

Regularly inspect mounting bolts for tightness to prevent leakage. Do not over-tighten, as it may damage the gasket. Eventually, the gasket will need replacement.

Wall Mount (if equipped)

Clean the air inlet grill and cabinet with a damp cloth and mild detergent to maintain cleanliness.

POWER ROOF VENT (IF EQUIPPED)

The 12-volt DC attic fan (or powered roof vent) allows fresh air to circulate through the recreational vehicle. Avoid leaving the attic fan open during storage or extended periods of unattended time to prevent leakage due to high winds or obstructions.

For optimal use, close all vents and slightly open a shaded window to direct airflow. Control the roof vent using either a control pad or touch screen, if equipped

For additional safety and operating information, refer to the manufacturer's user guide included in your Customer Information Packet.

FIREPLACE (IF EQUIPPED)

Your recreational vehicle may include an electric fireplace insert. For detailed operating and safety information, refer to the manufacturer's user guide included in your Customer Information Packet.



HEATING & COOLING

CEILING FAN (IF EQUIPPED)

⚠ WARNING ⚠ See page 80

To operate the ceiling fan, use the wall switch or the switch located in an overhead cabinet. The fan has three speeds controlled by a pull chain switch: Off, High, Medium, Low. The direction of operation is controlled by a slide switch on the fan itself: down for forward, up for reverse. Ensure the fan is stopped before adjusting the direction switch.

NOTE

During cooler temperatures, adjust the fan settings to "low" and set the fan to turn clockwise to create an updraft, facilitating the circulation of warm air. In summer, set the fan to turn counterclockwise to generate a down draft of cooling air.

For additional information refer to the manufacturer's owner's manual in the Customer Information Packet.

FURNACE

⚠ WARNING ⚠ (See page 80)

The furnace in your RV is controlled by a 12-volt DC thermostat, with up to two thermostats depending on your model, allowing temperature control. It operates on both 12-volt power and propane gas. Ensure adequate power before use. Furnace maintenance should be done annually by a qualified RV technician. Do not attempt DIY repairs.

Ducting & Return Air

Ensure all heat discharges, registers, and return air grills are unobstructed. Avoid completely shutting off closeable registers to maintain airflow.

NOTE

For RV models with touch screens, the furnace controls may be included on the selectable menu screens of the touch screen and in the JayCommand/TravelINK smartphone app.

Heat Pump Operation (If Equipped)

When using the heat pump, select either electric or gas heat on the thermostat. The heat pump serves as the primary heat source unless the interior temperature drops 5° below the thermostat set point, in which case the gas furnace automatically activates.

Once the set point is reached, the heat pump resumes as the primary heat source. For models with touch screen systems, heating and cooling controls are available on the touch screen.

Refer to the manufacturer's owner's manual or consult your dealer for further details.



HEATING AND COOLING WARNING

CEILING FAN (See page 80)

Be careful to avoid placing any object in the path of the ceiling fan blades!

FURNACE (See page 80)

- The furnace should be inspected periodically (monthly during the heating season) for presence of soot on the vent. Soot is formed whenever combustion is incomplete. This is a visual warning that the furnace is operating in an unsafe manner. If soot is observed on the vent, immediately shut the furnace OFF and contact a qualified service agency. Operating the furnace under this condition could lead to serious property damage, personal injury or loss of life.
- To ensure your personal safety, do not obstruct or alter the furnace in any manner. Do not install screens over the vent for any reason. Screens will become restricted and cause unsafe furnace operation. For your safety, only the manufacturer's factory authorized parts should be used on your furnace.

SECTION 10: APPLIANCES



MICROWAVE

⚠ WARNING ⚠ ⚠ CAUTION ⚠ (See page 86 and See page 87)

For detailed operation, cleaning, and safety guidelines, refer to the manufacturer's user guide included in your Customer Information Packet.

General Cleaning Microwave and Convection Microwave:

Ensure all controls are off and the microwave oven is cool before cleaning. Follow label instructions on cleaning products. Use mild soap, water, and a soft cloth or sponge to clean the interior, exterior, and filters of the microwave to prevent damage. For stainless steel, use a stainless steel cleaner. Avoid dishwasher cleaning of any components.

COOKTOPS, RANGE AND OVEN (IF EQUIPPED)

⚠ WARNING ⚠ ⚠ CAUTION ⚠ (See page 86 and See page 87)

For detailed operating, cleaning, and safety information for any of the devices listed below, refer to the manufacturer's user guide.

Electric Cooktop

- Electric cooktops work when connected to a 120-volt power source.
- Ensure the burner is turned off when not in use, and be cautious as the burner area may remain hot even after use.

Induction Cooktop

- Induction cooktops work when connected to a 120-volt power source.
- Only compatible with induction-ready cookware featuring an iron bottom, which heats when placed on the cooktop. Exercise caution to avoid placing other metal items on the cooktop.

Gas Drop-In Cooktops

Depending on your model, it may be equipped with either a 2 burner or 3 burner cooktop. See the manufacturer's instructions for operation information.

Kitchen Range and Oven

- To minimize condensation and cooking odors, activate the overhead kitchen roof vent or the range hood vent (if available).
- Always use pans recommended by the manufacturer to prevent damage. The pan should cover the burner adequately but not exceed one inch larger than the burner grate.
- Avoid using broiler pans, griddles, or large utensils that cover multiple burners simultaneously, as this can lead to excessive heat, melting, sooting, or discoloration.
- Using undersized pans may expose heating elements, potentially causing ignition of clothing. Proper pan-to-burner alignment enhances efficiency.

Oven

The propane gas oven requires 12-volt power to operate. **Do not use the oven as a storage area.** If you have any questions, contact your dealer.



APPLIANCES

RANGE HOOD (IF EQUIPPED)

⚠ WARNING ⚠ (See page 87)

If your RV is equipped with a range hood, it will be connected to an exterior vent. The vent has an inner flap with two snaps. This flap should be snapped shut when the RV is in motion, or during storage to keep insects, debris, snow, rain, etc. from entering the RV.

When using the stove inside the RV, unsnap the flap and activate the range hood to vent fumes outside the RV.

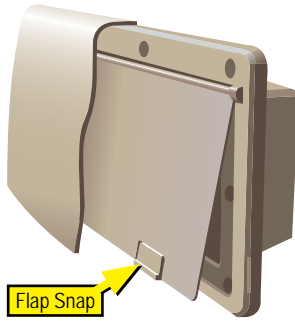

Push near top of snap to close.
Lift from bottom of snap to open.

Range Hood Exterior Vent Cover

COOKING SAFETY

Grease is flammable, so prevent its accumulation around burners or on the cooktop surface. Immediately wipe up spills and stay near when cooking.

In Case Of a Grease Fire

1. Turn off the heat source.
2. Extinguish the fire:
 - For pan fires, cover with a metal lid or cookie sheet until cool.
 - Smother with baking soda or salt.
 - Use a Class B dry chemical fire extinguisher

Avoid using water, moving the pan outside, or using flour or baking powder, as they can worsen the fire

If unable to extinguish the fire, evacuate and call emergency services (911).

REFRIGERATOR

Avoid quick freezing or cooling; stock with pre-frozen or pre-cooled food when possible. Arrange food to allow air circulation; keep shelves free of paper or plastic. Keep the rear area clean and free of debris, and check and remove obstructions from the exterior vent area.



For detailed operating, cleaning, and safety information for any type or refrigerator listed below, refer to the manufacturer's user guide located in the Customer Information Packet.

Gas/Electric Refrigerators (if equipped)

⚠ WARNING ⚠ (See page 87)

Control panel typically includes Power, Mode, and Temperature Set buttons. Modes include Auto (recommended), Manual AC/DC, and Manual Gas. Temperature Set adjusts internal temperature.

Night Mode (if available) reduces compressor speed for energy conservation and noise reduction.

Residential Refrigerators (if equipped)

⚠ CAUTION ⚠ (See page 87)

Residential refrigerators use 120V power either from shore power or the battery/inverter system when shore power is not available. Inverter controls are found in the command control panel/system.

12V Refrigerators (if equipped)

⚠ DANGER ⚠ (See page 86)

12V refrigerators run on the 12V electrical system only. Pay close attention to battery levels when not connected to shore power. These units do not have vents on the exterior of the RV.



JAYPORT™ AND GAS BBQ GRILL

⚠ DANGER ⚠ ⚠ WARNING ⚠ (See page 86 and See page 86)

Setting up the grill stand.

1. Locate the JayPort™ grill mount receiving hitch on your RV, either with a bumper mount system or a rail mount with a JayPort™ branded logo on the side of your RV (**Fig 1**).
2. Slide the grill stand into the JayPort™ until it stops (**Fig 2**).
3. Place the grill (if equipped or customer supplied) on the platform, ensuring it fits within the tray (**Fig 3**).
4. Attach the grill gas line to the quick coupler LP gas connection following the directions below.

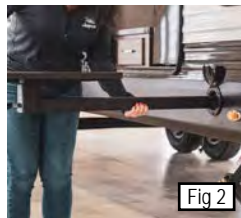
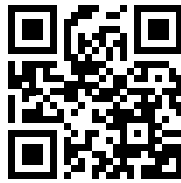

PROPANE GRILL QUICK COUPLER

Place the “quick coupler handle in the OFF position and push back the sleeve.

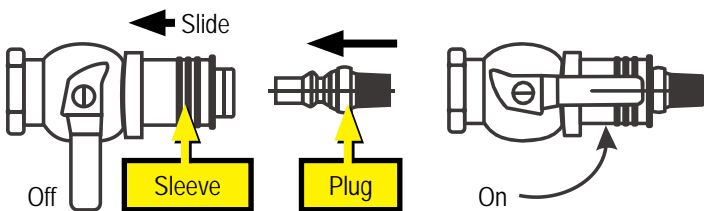

1. Insert the plug and release the sleeve.
2. Push the plug until the sleeve snaps forward, locking the plug into the socket.
3. Turn the handle ON to allow propane to flow to the unit.

OUTSIDE KITCHEN (IF EQUIPPED)

⚠ WARNING ⚠ (See page 86)

Consists of a small refrigerator, possibly an outdoor sink, and/or cooktop. Refer to the manufacturer’s user guide for detailed operation and safety information on the appliances.

- Ensure the outside kitchen is level for efficient operation.
- Check access and locking functions as per your model.



Outside Kitchen Example

When Using the Outside Kitchen:

- Secure all supports before use.
- Verify the propane connection is properly hooked up and secure.

- Never leave the cooktop unattended.
- Keep clothing and flammable materials away from the cooktop.
- Do not exceed the weight capacity of the outside kitchen.

Before Traveling:

- Disconnect the propane coupler before stowing the unit.
- Ensure the kitchen unit is properly stowed and secured, and the outside kitchen door is locked.

LP Gas Grill (if equipped)

⚠ WARNING ⚠ (See page 86)

Some models may include an LP fueled BBQ grill in the outside kitchen. This grill may be mounted in a pull out drawer. It attaches to the LP tank using a quick coupler connection as described in the “PROPANE GRILL QUICK COUPLER” section to the left.

For detailed operating, cleaning, and safety information refer to the manufacturer’s user guide.

TAILGATER CAMP KITCHEN (IF EQUIPPED - SEISMIC)

⚠ WARNING ⚠ (See page 86)

Your RV may be equipped with an optional Tailgater Camp Kitchen. It contains a pullout 2-burner cooktop and a small refrigerator. These components are enclosed in a lockable weather-resistant enclosure mounted on the rear of the RV.



Brackets allow the entire enclosure to pivot and swing away from the cargo ramp. The optional barbecue grill can also be attached.

Releasing The Outside Kitchen

1. Remove the pin from the upper rear hinge (A).
2. Remove the keeper cable from the pin at the right rear of the outside kitchen and pull the pin out of the bracket (B).
3. Open the outside kitchen and pull the inside handle (C) to release the two latches on the rear right and left corners of the enclosure. The enclosure will now swing away from the rear of the RV.

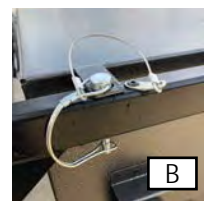

Latching The Outside Kitchen

1. Push outside kitchen back in place against the rear brackets. The enclosure will latch on each side at the lower rear corners. You should hear it click into place.
2. Replace the pin and the keeper cable at the top right rear corner of the enclosure (B).
3. Replace the pin on the top rear hinge (A).
4. Lock the lid of the enclosure with the keyed locks.

When not in use, the outside kitchen enclosure should be closed and locked.

APPLIANCES

Hooking Up Power

Lighting and the refrigerator in the kitchen require power to operate. To plug the outdoor kitchen into power:

1. Open the power cord access panel at the back of the unit (D) and pull the power cord through it.
2. Plug power cord into available outlet on the RV sidewall (E).



LED Kitchen Interior Lighting

To illuminate the LED lighting built in the outside kitchen, once power has been enabled, flip the lighting switch (F), found at the top center of the interior of the kitchen, to 'On'.



Connecting The Grill To The Propane "Quick Coupler"

Install the provided grill propane line between the grill connector (G) through the access hole (H) at the bottom center of the outside kitchen, and the quick coupler (I) found under the outside edge of the RV.

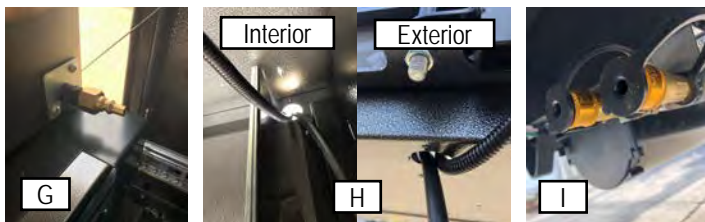

See "PROPANE GRILL QUICK COUPLER" on page 83 for instructions on using the Quick Coupler.



Installing the TV Mount (if equipped)

The Tailgater Camp Kitchen may be equipped with a TV mount (J).

To install the TV extension arm to the mount:

1. Locate the TV extension arm (if equipped), and install a TV to the available VESA mount (K) following instructions provided by your television's manufacturer.
2. With a TV mounted via the VESA connector, place the top of the mounting bracket on the extension arm into the top of the TV mount as show (L).
3. Rotate the bracket down until the bottom of the bracket locks into the TV mount. You should hear a click.



To remove the TV extension arm, while supporting the television, pull the lever (M) to unlock the mounting bracket, and lift to remove the arm assembly from the mount.

WASHER/DRYER PREP (IF EQUIPPED)

⚠ WARNING ⚠ **⚠ CAUTION ⚠** (See page 87 & See page 87)

Intended for aftermarket washer/dryer combo unit installation (customer supplied) only.

Consult dealer or manufacturer for installation assistance.

For dryer installation, a vent opening must be cut into the sidewall of the RV.

A label is provided to guide vent placement.

If prep is not near a sidewall, a sticker on the floor indicates where to cut a vent access into the lower storage area.

Another sticker on the sidewall within the storage area shows where to cut the hole for the exterior vent. This allows duct line installation from the dryer, through the floor, to the exterior vent.

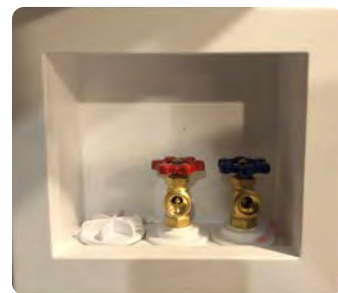

Washer Water & Drain Connections



Dryer Vent Hole Cut Location Sticker

APPLIANCES

CENTRAL VACUUM SYSTEM (IF EQUIPPED)

⚠ WARNING ⚠ (See page 87)

The following is an overview of the central vacuum system operation. For detailed operating and safety instructions, refer to the manufacturer's user guide found in the Customer Information Packet.

The central vacuum system offers cordless cleaning with various attachments. Simply attach the hose, lift the cover, and it activates automatically. It includes a Broom Debris Vacuum for easy cleanup. Maintenance involves checking and replacing the disposable bag located in the exterior compartment.



Cargo Area Vacuum Access

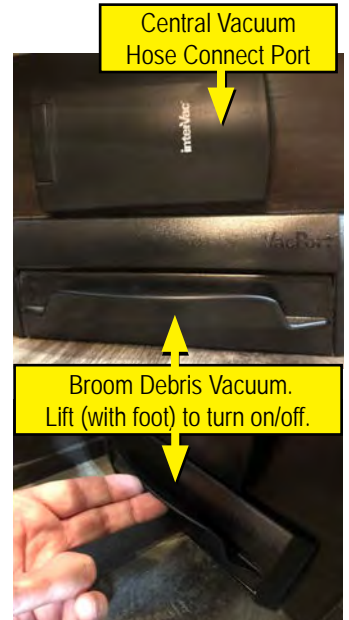

Interior Vacuum Access



APPLIANCES



APPLIANCES DANGER

JAYPORT™ AND GAS BBQ GRILL (See page 81)

Always open the grill lid before turning on gas and lighting burner to prevent an explosion causing property damage, injury, or death.

12V REFRIGERATOR (See page 82)

RISK OF FIRE OR EXPLOSION. Flammable refrigerant used. Do not use mechanical devices for defrosting or puncture refrigerant tubing. Repairs should be done only by trained personnel.



APPLIANCES WARNING

OUTSIDE KITCHEN (See page 83)

The maximum weight capacity of the outside kitchen unit is 50 lbs. Setting items on the kitchen unit that exceed this weight limit could cause damage to the unit or result in personal injury.

TAILGATER CAMP KITCHEN (See page 83)

Maximum weight capacity: 75 lbs.

Avoid exceeding weight limit to prevent damage or injury.

Do not use enclosure for accessory carrier or external gear.

Outside kitchen enclosure is not for storage

LP GAS GRILL (See page 83)

TAILGATER CAMP KITCHEN (See page 83)

- Ensure proper ventilation; designed for outdoor RV use only.
- Never place lava rocks, charcoal, or foreign objects on or under the grate to prevent injury or damage.
- Use supplied spade (grate handle) when the grate is hot.
- Follow RV instructions on propane use before operating; connect propane hose correctly.
- If gas odor persists, shut off gas, extinguish flames, and call supplier or fire department.
- Use outside the RV; ensure grill is fully extended from drawer before use.
- Install drip pan to catch grease; failure to use may cause burns.
- Cool grill completely before storing to prevent injury or damage.
- Do not cover cooking surface with anything to avoid unsafe situations.

JAYPORT™ AND GAS BBQ GRILL (See page 83)

Follow RV instructions for propane use.

Connect propane hose properly before lighting.

Failure to follow grill instructions may cause harm.

If gas odor persists, shut off and seek help.

Maximum weight for grill bracket: 50 lbs.

Use grill only outside RV, not in compartments.

Ensure secure mounting before use.

Allow grill to cool fully before storing to avoid injury or damage.

OUTSIDE KITCHEN (See page 83), TAILGATER CAMP KITCHEN (See page 83), JAYPORT™ AND GAS BBQ GRILL (See page 83)

Ensure vehicle is level and stabilized.

Adhere to required clearances for cooking appliances.

Wait until appliances are cool to store.

Failure to follow guidelines can lead to fire or explosion, causing serious harm.

MICROWAVE (See page 81)

The microwave cavity should always be empty when not in use. Never use for storage.

COOKTOPS, RANGE AND OVEN (See page 81)

Avoid contact with hot surfaces until cooled. Never leave cooking unattended; turn handles inward. Use appropriate-sized pans to prevent boil-overs. Ensure cookware is suitable for the top burners.

Do not cover oven vent openings during operation to prevent asphyxiation risk.

APPLIANCES

RANGE HOOD (See page 82)

When the stove is in use, range hood **MUST** be turned on, and the inner flap **MUST** be unsnapped and free to move. Failure to do so can create an asphyxiation hazard by restricting airflow through this vent.

GAS/ELECTRIC REFRIGERATORS (See page 82)

If you smell propane gas **STOP!** Follow the directions located in your manufacturer's user guide and in this manual under.

WASHER/DRYER PREP (See page 84)

Gas dryers should **NEVER** be installed in your recreation vehicle. Dryer prep has been designed for electric dryer operation **ONLY**.

CENTRAL VACUUM SYSTEM (See page 85)

Avoid vacuuming anything that is burning or smoking, such as cigarettes, matches, or hot ashes. Do not vacuum flammable or combustible liquids like gasoline or use the vacuum in areas where they may be present.

Failure to observe these precautions may result in RV damage, personal injury, or death



APPLIANCES CAUTION

MICROWAVE (See page 81)

To prevent damage, remove the turntable from the microwave when traveling. Make sure you are connected to a 120-volt power source.

COOKTOPS, RANGE AND OVEN (See page 81)

Never use oven cleaners, chlorine bleach, ammonia, or glass cleaners with ammonia. Always allow the cooktop to cool before cleaning.

ELECTRIC COOKTOP (See page 81)

Do not use aluminum foil on the electric range cooktop, as this material will damage the cooktop surface if it melts.

RESIDENTIAL REFRIGERATORS (See page 82)

Turn off the ice maker and empty the ice tray when power is shut off. Melting ice without power can cause water to pool in the refrigerator door. Upon power restoration, vibration may cause water to run out of the door onto the floor.

WASHER/DRYER PREP (See page 84)

Do not operate a dryer in the recreation vehicle unless the dryer is properly vented.



SECTION 11: ELECTRONICS



WINEGARD® AIR™ 360 ANTENNA

HDTV/FM Radio Antenna

Your RV comes with an exterior, fixed-height, high-definition TV and FM radio antenna positioned 8 inches above the roof. For detailed operating and safety information, please refer to the manufacturer's manual.



Omnidirectional HDTV Antenna (Style May Vary)

WineGard® Air™ 360 Plus (if equipped)

The Plus model includes an HDTV antenna amplifier, a Wi-Fi extender antenna for capturing nearby Wi-Fi signals, and is capable of connecting to 4G or 5G networks (requires a data plan). To utilize the Wi-Fi and 4G/5G features, you'll need the optional Winegard Gateway Router.

NOTE

A channel scan must be run to search for and tune in local TV channels. Trees and foliage will interfere with OTA (Over-The Air) high definition channel reception.

Antenna Power Supply (if equipped)

Switch ON for enhanced TV station reception by supplying 12-volt DC power to the TV roof antenna. Switch OFF to use cable television. The switch is located on the wall plate near the TV in the main living area, and an LED indicates when the antenna power is ON.

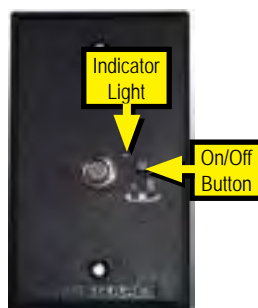

Power Supply Switch

Wi-Fi Router and 4G/5G Prep (if equipped - Plus Only)

Your RV may be equipped with Wi-Fi/4G/5G prep, located on the ceiling directly beneath the roof-mounted HDTV antenna. Wiring beneath the cap connects a compatible gateway router to the Wi-Fi and 4G/5G antennas within the HDTV antenna dome. For more information, consult the documentation provided by the HDTV antenna/router manufacturer.

WINEGARD® GATEWAY ROUTER (IF EQUIPPED)

Your RV may come equipped with a router that is compatible with your HDTV antenna, or your dealer may install a compatible router at the Wi-Fi prep location, if available. An installed router boosts weak external Wi-Fi signals, serves as a Wi-Fi hotspot, and can connect to 4G or 5G networks (requires a data plan). For detailed information, refer to the documentation provided by the router manufacturer.



Wi-Fi Prep Location (Found on Ceiling of RV)

This router establishes a cellular data connection through a SIM card provided by your cellular provider or by Winegard. The Winegard SIM card is pre-installed in the router box (requires a data plan). Presently, the system is compatible with the following wireless providers: Winegard, Verizon, T-Mobile, and AT&T. You can obtain a SIM card from your cellular provider.



Gateway Router

A power switch located next to the prep location/router controls the router's power. Leaving the switch continually ON can gradually drain your battery. Therefore, it's recommended to turn the switch OFF when leaving the RV or when the network is not in use.

NOTE

You MUST turn the power switch ON or there will be no cellular or Wi-Fi signals from the router box.

Winegard® Mobile Apps

Winegard offers two free apps available for download on Android or iPhone devices to assist in locating TV and satellite signals: TV Signal Finder and HD Tower Finder. These apps help determine HDTV tower locations and satellite dish pointing coordinates.

Wi-Fi Control

To detect the SSID from the router and connect to the system, ensure that the Wi-Fi function on your smartphone, tablet, or other smart device is enabled.

Router Password, Serial number, IMEI number

This vital information may be found in one of the following locations:

- On a small vinyl tag (or label) near the entrance area of the RV. Look in a nearby cabinet for this label.
- On a tag (or label) attached to the Winegard Gateway instruction manual included in your Customer Information Packet.
- On the backside of the ceiling-mounted router box.

Router Setup:

You can set up the router using a cell phone connected to the internet via the Winegard-Connected app, or through the JAYCOMMAND/TravelLink system (if equipped). Please refer to the user guides for JAYCOMMAND/TravelLink and the router for detailed instructions.

CAMERA PREP/CAMERA (IF EQUIPPED)

CAUTION (See page 90)

Camera Prep

Your RV may come pre-wired to facilitate the installation of a



Rear or Door Camera Prep



Side Marker Camera Prep

rear vision, door, and/or side marker camera (customer supplied and customer installed). To install a camera, please consult the manufacturer's installation guide.

Camera/Monitor

The rear and side vision monitor provides a limited televised view of what is behind and alongside your vehicle.



Rear or Door Camera



Side Marker Camera

Cameras are powered alongside the JaySMART™ safety marker and reverse travel lighting system when your tow vehicle's headlights are turned on. The monitor's display will switch to the appropriate side marker camera when a turn signal is activated.

For detailed operating and safety information, refer to the manufacturer's user guide.

Some models feature a camera accessory power wire pre-routed behind the bedroom light switch or, if no light switch is present, behind the command center panel near the entrance door. Utilizing this wire, a switch can be installed to control the camera's power when the RV is not connected to a tow vehicle.

If available, the wireless camera monitor can be plugged into the 12V power port in the bedroom for observation or security purposes.



12V Power Port

EXTERIOR SLIDING / PIVOTING TV (IF EQUIPPED)

Your RV may come equipped with a TV located in an exterior compartment, offering the convenience of sliding it in and out of the compartment and pivoting it for optimal viewing.

Extending The Tv For Viewing:

1. Push down the yellow-tipped lever to release the sliding bracket.
2. While holding the yellow lever down (A), pull the TV towards you out of the compartment. Once you start sliding the TV out, release the lever and continue pulling it out, ensuring cords are not caught in the mechanism.
3. Extend the silver brackets on the back of the TV, ensuring the TV is completely out of the compartment by pulling it until the top black slide bracket (B) reaches the end of the channel (C). The TV should clear the lined panel inside the compartment when fully extended (D).
4. To pivot the TV, pull up on the T-handle (E), allowing the TV to pivot freely.

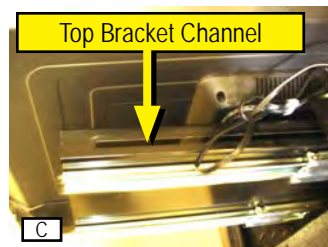
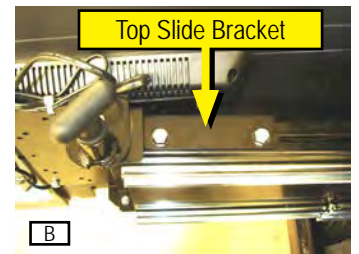
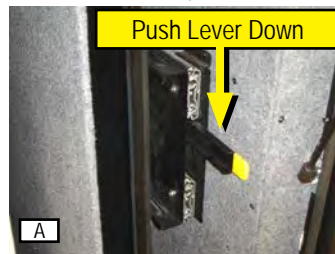

NOTE

The TV does not lock into place when it is in the pivoting position.

Retracting The Tv For Storage:

1. Rotate the TV back into the storage position to lock the T-handle (E) in place and prevent pivoting.
2. Push the TV into the storage compartment, ensuring the power cord and antenna cable do not get caught in the mechanism.
3. Push the TV all the way back into the compartment until it stops. Firmly push it into place until the yellow-tipped lever locks it securely, indicated by a click sound.



CAMERA PREP/CAMERA (See page 89)

Camera/monitor system aids in the use of, but does not replace vehicle side/rear-view mirrors.

Objects in camera/monitor view are closer than they appear. When backing up, proceed cautiously and be prepared to stop.

SECTION 12: INTERIOR



CLEANING THE INTERIOR

Regular maintenance is crucial to preserve your RV's value. Use recommended cleaners to avoid damage. Avoid flammable or abrasive products.

Fabric, Leather, and Ultraleather™ (if equipped)

Seek professional cleaning for stains. Inform cleaners of fire-resistant treatments.

Window Treatments

Dust occasionally. For stains, seek professional cleaning. Inform cleaners about fire-resistant treatments. Refer to manufacturer's manual for details.

NOTE

If your RV must be stored for an extended period, store shades in the up position and cover your windows with additional protection.

SOFAS AND DINETTES

Your RV may be equipped with one or more of the following sofa styles.

TriFold Sofa Sleeper (if equipped)

To make the sofa sleeper into a bed:

1. Remove the back cushions and lift up from the front of the bottom seat cushion and pull it towards you.
2. Extend the legs under the seat cushion area and lower to the floor (B).
3. Pull the head board towards you (C).
4. Put the back cushions back in place at the back (D).

To convert the hide-a-bed back into the upright sofa position, reverse the process.

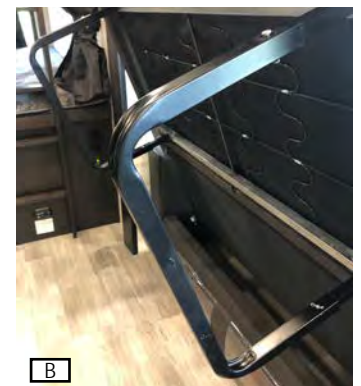

INTERIOR

Jack Knife Sofa

To make the sofa into a bed, lift up on the bottom seat cushion (E) and pull it towards you. The sofa back will drop down to provide a sleeping surface (F). For additional comfort and to reduce fabric damage, you may want to place a cover or air mattress (customer supplied) over the sofa when it is in the sleeping position.



E



F

Jay Cube™ Sofa (if equipped)

The Jay Cube™ Sofa functions similar to a residential futon. The slanted back pillows offer numerous options as a sofa, along with the ability to extend the cushions for additional sleeping space.



Booth Dinette (if equipped)

The dinette is designed to seat up to four adults. Depending on your model, there may be a storage area in the dinette bench. To access this storage, remove all the cushions and lift up on the bottom seat support. **If the bottom seat support is secured closed with screws, do not remove the seat support or use this area for storage.** The dinette seats that are secured with screws contain factory installed equipment and should only be accessed by a qualified service technician.



G

To convert the dinette into a bed:

1. Remove all the cushions from the booth dinette.
2. Lift up the tabletop and remove the detachable table legs.
3. Place the tabletop on the ledges provided between the booth dinette benches (H).
4. Lay the seat back cushions on each dinette bench.
5. Lay the dinette seat bottom cushions in between the seat back cushions (I). The area where the cushions meet should be slightly raised. Push the raised cushion ends down gently as the cushions are designed to fit snugly.



H



I

Reverse this process when converting back to the booth dinette.

Free-Standing Table and Chairs (if equipped)

The free-standing dinette table can be positioned to seat up to four people. To prevent damage, the free-standing dinette chairs should be fastened securely at the dinette table when traveling (J).



J

Table extension (if equipped)

Pull to lengthen (K). Lift the main top and push in to shorten.



K



TOKYO BED (IF EQUIPPED)



The cargo bay of a toy hauler may feature a Tokyo Bed, utilizing a scissor rail system for raising and lowering. To lower, pull down on the hanging strap until the bed stops, ensuring no obstructions below. Avoid sleeping in the bed when internal combustion engines are stored beneath it.

To store the bed, ensure it's empty, then push it back up. Never attempt to raise the bed with a person on it. A ladder is provided for accessing the bed when lowered; store it when not in use.

Keep the bed empty and raised during travel and when not in use; it's not for storage. The maximum weight capacity is 550 lbs; do not exceed this rating.

POWER BUNK BED (SEISMIC CARGO BAY)

⚠️ DANGER ⚠️ ⚠️ WARNING ⚠️ ⚠️ CAUTION ⚠️

(See page 97 and See page 97 and See page 97)



Your RV may feature a queen-size power bunk bed in the cargo bay, accompanied by powered sofa seats that convert into a second queen size bed. These sofa seats can be raised to the ceiling underneath the power bunk bed to facilitate cargo loading, using the same controls as the queen bed.

CHECK:

- Ensure all attaching pins are securely fastened at all four corners of the bed platform before towing the trailer or using the beds.

- Clear the area around, above, below, and adjacent to the beds of persons, pets, and obstructions before operating.
- Avoid overhanging bedding at the ends of the beds to prevent entanglement.
- Set the brake on the bed lift mechanism to prevent drifting and potential damage to objects below.

NEVER:

- Operate the beds with items other than the mattress, pillows, and blankets on the platform.
- Raise the sofa seats when set in the seated position; they must lay flat and be locked.
- Travel with loose items on the beds as they can become projectiles.
- Operate the beds with persons on the platform.
- Hang more than 20 pounds from the cross-connecting shaft.
- Allow anyone on the beds while the RV is in motion.

ALWAYS:

- Exercise caution when loading cargo/vehicles in the cargo area to avoid damaging the bed mechanism.
- Properly secure loads in the cargo area to prevent damage from shifting or falling loads.

Bed Operation

The electric bed lift operates on 12-volt DC power from the tow vehicle charge line, auxiliary batteries, or power converter.

Ensure the RV is connected to 120-volt AC power with the power converter operating if possible.

Use two separate switches to operate the bed lift: a red-lighted master shutoff switch and the bed lift up/down switch, typically located in the command center panel or cargo bay area.

Turn on the red master switch first to lower or raise the beds using the bed lift control. Remember to turn off the master switch after moving the beds.

Lowering Both Beds

- Press "Down" on the Bed Lift Switch Control.
- Both beds will lower simultaneously until the upper bed reaches the pre-set stopping point.
- The bottom convertible sofa will continue lowering until it also reaches a pre-set stopping point.
- Ensure to lower the sofa legs before bringing the convertible sofa to the bottom position.



Bed Lift Control Up/Down Switch



Adjustable Sofa Leg

INTERIOR

Raising the Beds

Before raising the beds, set the lock levers on each rail to the "Lock Bunk" down position. You **MUST** set all 4 levers.

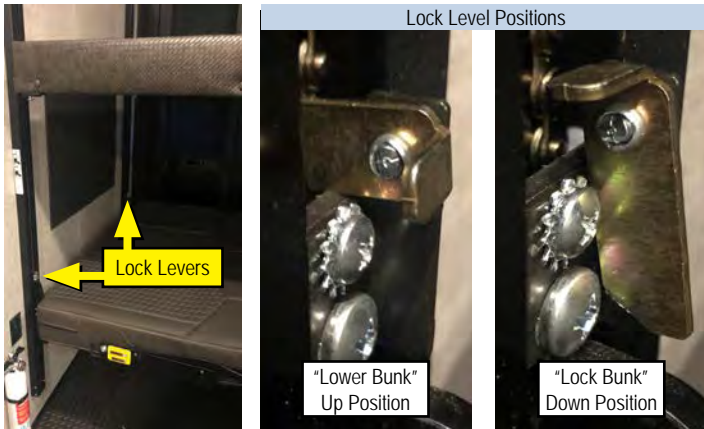

- Press "Up" on the Bed Lift Switch Control until the top bunk reaches maximum height and locks into place.
- When raising the beds, the bottom bed will rise until it meets the upper bed, then both will rise to the highest point.
- Once the upper bunk is locked, you can keep both bunks in this position (ensure sofa legs are locked up) or lower the lower Convertible Sofa independently for use (ensure sofa legs are down). Refer to the Convertible Sofa section for prep instructions.

Lowering the Upper Bunk for Use

- Ensure the Convertible Sofa is in bed configuration.
- Set all 4 lock levers on each rail to the "Lower Bunk" up position.
- Press "Up" on the Bed Lift Switch Control until the Convertible Sofa reaches and unlocks the upper bunk.
- Follow the steps in the "Lowering Both Beds" section above.

Emergency Manual Override:

- In case of motorized lift failure, an emergency manual override allows manual lowering or raising of the beds.

Refer to the manufacturers' bed-lift user manual for additional information on upper bunk operation, stowing, manual override, and troubleshooting

Storing the Sofa on the Wall

⚠ WARNING ⚠ (See page 97)

In case you need additional width in the cargo area, the Convertible Sofa can be stored against the sidewalls.

1. Ensure the Convertible Sofa is in bed configuration, and the upper bunk is at its maximum height.
2. With the back door open and preferably with two people, press 'UP' on the Bed Lift Switch Control to raise the Convertible Sofa at least 5 feet from the floor.
3. Insure the Sofa Lock is in the Locked position.

4. With one person on each end of a sofa seat, remove the locking pins (E) on each side. Support the seat with one hand as you remove the pin with the other.
5. Lift the seat from both sides and pull slightly away from the wall.
6. Lower the seat to the sidewall.
7. Replace locking pins to prevent loss.
8. Repeat the process for the other side.



To return the sofa to seating position, reverse the above procedure.

Convertible Sofa

To convert the sofa into the bed position, pull forward on the top of the sofa back (A). As the sofa back comes forward, grasp it at the bottom and rotate the seat back until it reverses (B) and lays flat next to the sofa seat (C). Repeat this process on the sofa on the other side of the RV. Set the sofa lock mechanism to the "LOCK" position (D) This locks the sofa into the bed position.



To convert back into the sofa position, reverse the process.

NOTE

The bed must be fully lowered to convert it into the sofa.



MURPHY BED (IF EQUIPPED)

CAUTION (See page 97)

Your RV may feature a folding Murphy bed, maximizing living space by storing it in the wall when closed. To use the bed, the sofa folds flat and the bed is pulled down over the sofa into the sleeping position.



Stored Position



Sleeping Position

Unfolding the Sofa

- Fully extend the slideout.
- Stand at the side of the sofa and grasp the front of the seat cushion and the top of the back cushion (A).
- Lift up on the seat cushion while pulling the top of the back cushion toward the seat, forming a "V" shape (B).
- Pull the seat cushion out away from the front of the sofa into the flat position (C).



Lowering the Murphy Bed

- Unlatch the bolt latches on one or both sides of the bed platform in the stored position to release the Murphy bed.
- The bed will unfold. Lower it completely until the bed platform rests on the flattened sofa.



Bolt Latch

Storing the Murphy Bed

WARNING (See See page 97)

- Push the bed back up into the storage position until the bolt latch or latches click into place.
- Test the bolt latch or latches to ensure they are secure.

Returning the Sofa to Seated Position:

- Firmly grasp the edge of the top cushion and the front edge of the seat cushion.
- Push the cushions down and towards each other to form a "V" shape. While holding the cushions in this "V" shape, rotate the sofa back towards the wall, and the cushions will revert to the seated position.

STANDARD BED STORAGE

WARNING (See page 97)

Additional storage has been provided under the bed. To access the storage area, grasp the ledge at the foot of the bed and lift carefully. ***The bed platform must be held when raised.***

It is recommended that two people retrieve stored items from under the bed so that one person may hold the platform, and the other can retrieve the stored items from under the bed. Lower the platform slowly to close it. **DO NOT DROP THE PLATFORM.**

Gas Struts (if equipped)

On certain models, gas struts assist in accessing the storage.

- Grasp the ledge at the foot of the bed and lift carefully.
- Two gas struts hold the bed platform open for easy access.
- To close, carefully push down on the bed, easing it slowly to the closed position.



INTERIOR

BUNK BED AND LOFT LADDERS (IF EQUIPPED)

⚠ WARNING ⚠ (See page 97)

Your RV may include a loft or bunk bed sleeping area, accessed via a steel or wall-mounted wooden ladder.

NOTE

Some types of bunk beds do not include a ladder.

Steel Ladder

The steel ladder (A) features hooks (B) fitting into mounting points on the side board of the loft bed or over its edge. Ensure the ladder is securely in place before climbing to or from the loft. Store the ladder when not in use to maintain access to nearby doors.

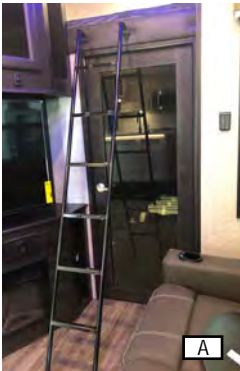

Wood Ladder

The wooden ladder is typically wall-mounted (C). Lift and pull to position the ladder for climbing (D). Reverse the procedure to store the ladder when not needed.



BED RAILS

(FOR ELEVATED BEDS AND ELECTRIC BED LIFT SYSTEMS)

⚠ CAUTION ⚠ (See page 97)

Standard Elevated Beds

Elevated beds, typically 4 to 5 feet above the floor, may lack bed rails due to their various designs and uses.

Electric Bed Lift Systems

Rear cargo area electric bed lift systems in certain trailers may not include bed rails due to their adaptable configurations.

Use of Bed Rails

Customers are encouraged to assess if bed rails are necessary based on intended use and user comfort. Numerous bed rail styles are available for purchase, ensuring proper fit and installation.

Follow manufacturer's instructions closely and consider mattress size for appropriate rail height.

Ensure adequate space for entry and exit, especially during emergencies.

Tips for Safe Usage:

- Exercise caution with children under 6 sleeping in elevated beds.
- Educate children on proper usage and supervise play in sleeping areas.
- Install night lights for visibility during nighttime movement.
- Adhere to weight restrictions and avoid horseplay or hanging items from the bed.
- Only one person should be on an elevated bed at a time.
- Electric bed lift systems should only be operated by adults, and no one should be on the beds during operation.

Contact our Customer Service Department with any questions regarding elevated beds, electric bed lift systems, or bed rails.



! DANGER ! INTERIOR DANGER

POWER BUNK BED (See page 93)

This product is designed and intended ONLY to be used as a Bed-Lift mechanism. Any other use of this system can result in personal injury or death.

! WARNING ! INTERIOR WARNING

POWER BUNK BED (See page 93)

DO NOT LOAD MORE THAN 600 lbs. ON THE BED. Damage to the bed lift mechanism and personal injury may result from overloading.

STORING THE SOFA ON THE WALL (See page 94)

Ensure the area around and below the bed is clear of persons, pets, and obstructions before lowering the sofa seats to the sidewalls. Failure to do so risks serious injury to anyone caught beneath.

STORING THE MURPHY BED (See page 95)

Keep hands and fingers away from the collapsing footboard and struts when pushing the bed back in to the storage position.

BED STORAGE (See page 95)

Before lifting, ensure there are no obstructions or added weight on the bed. Exercise caution by using the end ledge provided when opening or closing the bed to prevent hand or finger injuries. When opening the bed storage platform, hold it open (unless equipped with gas struts) and slowly lower it until closed.

Failure to follow these guidelines may result in serious injury or property damage.

BUNK BED AND LOFT LADDERS (See page 96)

- Exercise extreme care when climbing up or down the ladder for entering or exiting the loft bed.
- Ensure nearby doors are securely closed and latched before using the ladder.
- Confirm the ladder is securely in place before climbing to or from the loft.
- Never allow more than one person on the ladder simultaneously.
- Ensure the wood ladder (if equipped) is securely locked back when not in use to prevent tripping hazards.
- Do not leave small children unattended in the loft area.
- The maximum weight rating for either ladder type is 300 lbs (136 kg).
- Weight ratings for loft sleeping areas may vary by RV type and model; refer to the maximum weight rating label located at the loft sleeping location.
- Never allow anyone to ride in or occupy the bed while the recreational vehicle is in motion.
- Avoid using the loft sleeping area for storage while the vehicle is in transit, as loose items may become projectiles.
- Failure to follow these instructions may result in serious bodily injury.

! CAUTION ! INTERIOR CAUTION

POWER BUNK BED (See page 93)

To prevent bed damage from bouncing while towing, raise both rear beds to the highest position. Before raising the powered sofa seat/beds in the cargo bay, ensure they are folded flat into the sleeping position. DO NOT operate the bed lift with seats opened in the seating position. Lock seats in the flat (bed) position using the sofa lock mechanism.

BED RAILS (See page 96)

Max. load capacity: 300 lbs (136 kg). Beds must be stowed in the up position during travel. Elevated beds may pose a fall hazard, leading to injury. Refer to the Owner's Manual for more information on elevated beds and the use of bed rails.

Failure to comply with the load capacity could lead to bed failure, resulting in injury.

MURPHY BED (See page 95)

Ensure the slideout is fully extended before transitioning the Murphy bed to the sleeping position. The Murphy bed must be stored before moving the slideout to the in (travel) position to prevent injury or property damage.

SECTION 13: EXTERIOR



CLEANING THE EXTERIOR

To preserve your RV's exterior finish, wash it frequently and thoroughly. Your RV is exposed to various environmental elements that can harm the finish, including:

- Road Salt
- Road Tar / Bugs
- Bird Droppings / Tree Sap
- Industrial Fallout / Acid Rain / Pollution
- UV Exposure
- Moisture

These conditions can lead to corrosion, staining, and chemical spotting. Prompt cleaning can mitigate these issues. Wash your RV promptly if it comes into contact with foreign materials.

Avoid parking under trees, in direct sunlight, or near ocean salt spray. Brush off, rather than scrape, ice or snow from the surface. Steer clear of gravel roads.

Washing

- Avoid commercial washing and high-pressure sprayers. Wash with cold water using mild liquid soap. Dry wiping with a cloth is not recommended.
- Ensure the RV's surface temperature is under 90°F and out of direct sunlight. Use a shaded area to prevent water spotting.
- Use mild soap, detergent, or car wash shampoo. Wash-n-wax products are recommended.
- Have two dedicated sponges or wash mitts: one for the sides and one for the wheels and undercarriage.
- Wash wheels and wheel wells first to prevent splattering on panels. Wet the area, then hand wash one section at a time from top to bottom.

- Rinse frequently to minimize grit abrasion and finish with a final water rinse.
- For stubborn stains like road tar or bug stains, use ammonia-based glass cleaner or rubbing alcohol followed by warm soapy water.
- Avoid solvent-based cleaners for bird droppings or tree sap. Use ammonia-based glass cleaner, warm soapy water, and elbow grease.
- After removing stains, rinse immediately with clean water.

Drying:

- Tap water and well water contain chemicals that could stain the RV's finish. Use a damp natural or synthetic chamois or lint-free microfiber towels to dry.

Painted Surfaces

⚠ CAUTION ⚠ (See page 102)

- Wait 60 days after purchase before washing and waxing your new RV to allow the exterior paint to cure.
- Immediately rinse off spills of anti-freeze, gasoline, or washer solvents with water. Rinse bugs and bird droppings off daily.
- Wax your RV once or twice a year or when water no longer sheds well from painted surfaces.
- Apply a small amount of wax with a soft cloth, then polish with a dry, soft cloth after the wax has dried.
- Avoid waxing in direct sunlight and apply wax after surfaces have cooled.
- Do not wax flat black finished areas to prevent discoloration. Wipe off any wax stains with warm water and a soft cloth.
- When waxing around openings, avoid applying wax on weather strips to maintain weatherproof seals.

Damaged Paint Care:

- Lightly polish severely damaged painted surfaces with a fine polishing compound to restore luster and color tone.
- Extend polishing beyond damaged areas, moving the cloth in one direction.
- Flush the compound and apply wax to regain a beautiful luster.
- Touch up small cracks and scratches with touch-up film or paint to prevent corrosion. Check body areas facing the road and tires for damage caused by flying stones.

Plastic Parts

⚠ CAUTION ⚠ (See page 102)

Use warm water and a soft cloth or chamois to clean plastic parts. Remove white residue from dark plastic surfaces with warm water and a soft cloth. Avoid scrubbing brushes, hard tools, or abrasive wax to prevent damage.

Chrome Parts

Wash chrome parts with water, dry thoroughly, and apply non-abrasive automotive wax to prevent spotting or corrosion. Use a commercially available chrome polish product for severely damaged or pitted chrome.

Vinyl Decals

Regularly coat vinyl decals with a UV protective spray to maintain image quality. Avoid applying wax to decals and apply UV protective spray before washing the RV with a wash-n-wax product.

Underbody and Cold Weather

Salt and chemicals from winter roads can harm the RV's underbody. Spray the underbody with a high-pressure hose each time you wash the RV if exposed to these conditions. Remove mud and debris that can trap salt or moisture, and wipe off water drops from rubber parts around slideouts and doors after washing. Periodically inspect exposed exterior areas, repaint frame members when rust or paint chipping is noticed to ensure protection.

NOTE

When the slideout or door is frozen, opening it by force may tear off or crack the rubber gasket that is installed around the slideout or door. Pour warm water on the gasket to melt the ice (wipe off the water thoroughly after opening the slideout or door). To prevent the weather stripping from freezing, treat it with a silicone spray.

CLEANING SLIDE-OUT SEALS

Use household cleaners like 409®, Lysol®, or similar products.

Avoid chemicals that may degrade seal performance, including those found in certain caulks and sealants.

Review material ingredients before using any aftermarket sealant or caulk to prevent adverse effects on seal performance.



DO NOT USE

- | | |
|--------------------------|---------------------|
| • aliphatic hydrocarbons | • cyclohexanone |
| • amyl acetate | • ethers |
| • amyl alcohol | • gasoline (any) |
| • amyl chloride | • kerosene |
| • aromatic hydrocarbons | • lacquer solvent |
| • benzaldehyde | • linseed oil |
| • benzene | • methane |
| • benzoic acid | • naphtha |
| • benzyl alcohol | • natural gas |
| • butane | • nitrobenzene |
| • butyl acetate | • phenol |
| • carbon disulfide | • styrene |
| • chlorobenzene | • toluene |
| • chlorobromomethane | • trichloroethylene |
| • chloroform | • turpentine |
| • cresol | • vinyl plastisols |
| • cyclohexane | • xylene |

TEST BEFORE USING

- | | |
|---------------------------|-----------------------|
| • acetic anhydride | • acetic anhydride |
| • alcohols | • glycerin |
| • aniline | • iodine & solutions |
| • aniline hydrochloride | • monoethanolamine |
| • butyl alcohol (Butanol) | • oils, animal |
| • carbon tetrachloride | • oils, mineral |
| • ethylene glycol | • oils, vegetable |
| • ethyl alcohol (Ethanol) | • perchloroethylene |
| • fatty acids | • polyglycol |
| • freon | • steam (up to 40psi) |

EXTERIOR

E-Z LUBE® OR SUPER LUBE™ AXLE (IF EQUIPPED)

If equipped with E-Z Lube® or Super Lube™ axles:

- Grease fittings allow lubrication without removing hubs.
- Pump grease into the fitting to lubricate inner and outer bearings.
- Spin the wheel while filling for even grease distribution.

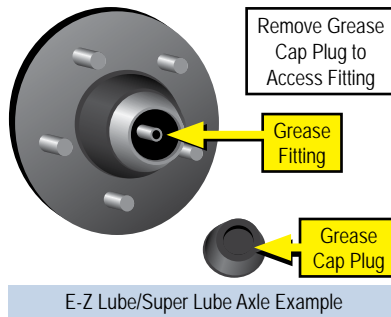

Contact your dealer for further assistance if needed.

NOTE

While E-Z Lube or Super Lube offers easy lubrication, it shouldn't substitute regular bearing inspection. Use a hand-operated grease gun to avoid seal damage. Improper commercial grease gun use may harm the seals.

EXTERIOR ROOF AND SIDEWALL VENTS

Regularly inspect roof vents and sealants for cracks and cleanliness. Check refrigerator and holding tank vents for blockages from nests, webs, or debris. Keep all exterior access doors and vents clear of obstructions, especially while appliances are in use.

WINDOWS

During heavy rainstorms, water may enter through ventilating windows. Condensation can also accumulate on windows and in the tracks.

For cleaning window glass, use a sponge and water. Use glass cleaner to remove wax, oil, grease, dead insects, etc. After washing, wipe the glass dry with a clean, soft cloth.

EXTERIOR LADDER (IF EQUIPPED)

⚠ WARNING ⚠ (See page 102)

Your RV may be equipped with an exterior roof ladder. The RV roof has decking under the rubber roof membrane to allow you to walk on the roof (with caution) to do maintenance.

Self-Storing Ladder (If Equipped)



Self-storing ladders, if equipped, can hold up to 250 lbs. Always store the ladder while traveling. To use the ladder:

Self-Storing Ladder Operation

1. Remove all pins from the ladder brackets (A).
2. Pull the ladder down and away from the RV; it will swing out.
3. When the brackets are extended (B), re-insert the pins to lock the ladder in place while in use.
4. To return the ladder to the storage position; pull the locking pins and push the ladder up and in towards the RV.
5. When the ladder is in the storage position, re-insert all locking pins to secure the ladder during travel.



On-The-Go Ladder (If Equipped)

If equipped, the On-The-Go collapsible ladder can support up to 330 lbs. Follow these steps for operation:

On-The-Go Ladder Operation

1. Disconnect the lock pins at the base and top of the ladder (C).
2. Raise the lock clasps (D) as the base and top of the ladder.
3. Lift the ladder out of the mount.
4. Place the ladder on level ground under the ladder receiver.
5. Release the Velcro ladder run retaining strap (E).
6. Raise each section of the ladder until it clicks into place.
7. Place the ladder at a 75 degree angle. The distance from the base to the RV should be about 1/4 the distance to the top of the RV.
8. Place the ladder mounting hooks firmly into the ladder receiver (F) on the side of the RV.

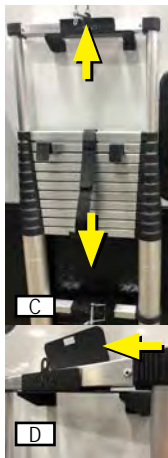

The ladder is now ready for use. For added safety have a second person hold the ladder during ascent and descent.

To store the ladder, reverse the procedure above. To collapse the ladder back to its original size, press the release buttons (G) on each side of each level simultaneously towards each other to lower each level.



Be careful not to have your fingers or other appendages between the rungs when the level is collapsing.

SEALANTS

⚠ CAUTION ⚠ (See page 102)

Sealants perform a very important function and should be inspected closely and regularly maintained. We incorporate many different types of sealants, including butyl/putty, black butyl-encapsulated foam, silicone (clear and colored), roof sealant and foam. In general, sealants do not have "set" lifetimes. Varying environmental factors affect the pliability and adhesiveness of sealants.

You Or Your Dealer Must:

- Inspect all sealants, a minimum of every six months. Make sure to check the roof and all four sides of the recreation vehicle including all moldings, doors, vents and exterior attachments. A quick walk around the recreation vehicle before leaving may help prevent potential problems during trips and vacations.
- Have the sealant replaced if you notice any cracks, peeling, voids, gaps, breaks, looseness or any sign of physical deterioration. Reseal at least one time each year as preventative maintenance.
- Always use the same type of sealant that was removed. Your dealer service or parts manager can help you obtain the correct sealant(s).

The sealants may become damaged due to road vibration, ultraviolet exposure, air pollution, freezing temperatures and exposure to other elements. Repair deteriorated sealants immediately to prevent damage. Cap seal all trim and openings at least once after the first year and thereafter as cracks, peeling, lifting and shrinkage occur.

If you notice water inside the recreation vehicle, immediately have the dealer check for the source of the leak. Failure to correct the leak may result in serious damage to your recreation vehicle, and this damage may not be warrantable.

If you have questions and/or need assistance with sealing your recreation vehicle, consult with your recreation vehicle dealer.

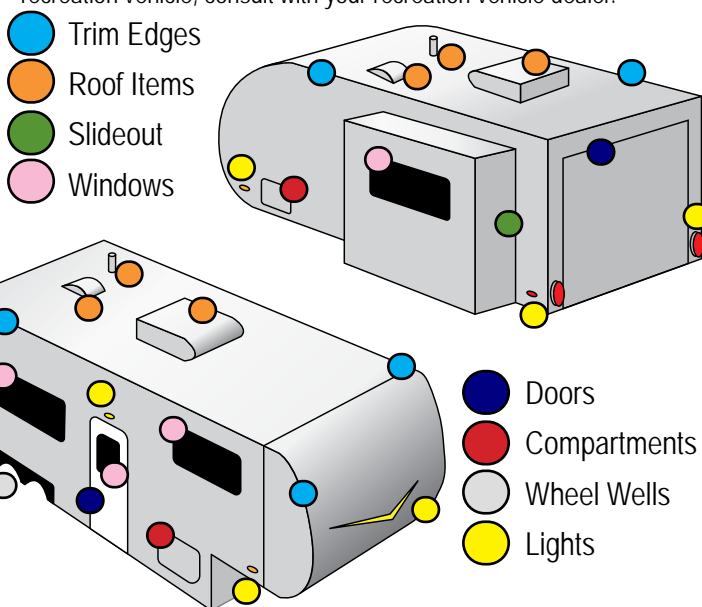

RV Sealant Diagram

**EXTERIOR LADDER (See page 100)**

Here are the safety guidelines for using the exterior ladder on your RV:

Weight Capacity: Ensure you do not exceed the weight rating of the ladder. The maximum weight capacity is typically 300 lbs (136 kg), including the weight of the person and any items carried.

Securing Items: Do not leave items attached to the ladder while traveling to prevent damage or accidents.

Pin Locking Mechanism: For self-storing ladders, unlock all pins before extending the ladder for use. Ensure all pins are re-inserted securely when locking the ladder open.

Climbing Safety:

- Always face the ladder while climbing.
- Climb slowly with your weight centered between the side rails.
- Maintain a 3-point contact on the ladder at all times, such as two hands and a foot, or two feet and one hand.
- Keep your hands free while climbing.
- Use accessories like lanyards to tether carried items and prevent them from falling.
- Bring heavy or bulky items up to the roof only after reaching the top.

Inspection: Do not use the ladder if it is damaged in any way. Regularly inspect the ladder for signs of wear or damage.

Failure to adhere to these safety guidelines could result in severe injury or death

**PAINTED SURFACES (See page 98)**

Do not use waxes containing high-abrasive compounds. Such waxes remove rust and stains effectively from the paint work, but they are also harmful to the luster of the painted surface since they scrape off the coating. Further, they are detrimental to glossy surfaces, such as the grille, garnish, moldings, etc. Do not use gasoline or paint thinners to remove road tar or other contamination to the painted surface.

Do not use a buffer and a buffing compound as it may damage the exterior surface. Please contact a professional paint body shop for assistance.

PLASTIC PARTS (See page 99)

Do not allow plastic to come into contact with brake fluid, engine oil, grease, paint thinner, or battery acid. These will damage plastic. Use a soft cloth and a mild detergent solution to wipe away any such contact.

SEALANTS (See page 101)

Failure to properly maintain or reseal your recreation vehicle may result in serious water damage to the roof and other parts of the recreation vehicle. This damage is not covered by the Limited Warranty.

To check the exterior sidewall sealants, use a stepladder placed safely alongside the vehicle. Do not prop a ladder against the body of the RV as it may damage the exterior finish.

SECTION 14: CHECKLISTS



TRAVEL CHECKLIST

Following is a comprehensive travel checklist for your RV. This is a general list, which you may want to customize as you determine your own needs.

For your convenience a quickstart guide is also available from within the JAYCOMMAND/TravellINK mobile phone app (if equipped) that walks you through the steps to setup your RV at the campsite or prepare it for travel.

Safety

- Follow all safety precautions mentioned in the owner's manual and any manufacturer's operator manual.

Maintenance

- Inspect seals and reseal as needed.
- Have the propane system checked for leaks by your dealer.
- Check wheel lug nuts after the first two hundred miles and at specified intervals, re-torque as needed.
- Have brakes adjusted by a qualified service technician.
- Sanitize the fresh water system.
- Test safety alarms.

Before Leaving Home (Or Campsite)

- Check all tow vehicle fluids.
- Check RV lights and tires for wear, pressure, and damage.
- Inspect safety chains, latches, and locks.
- Ensure batteries are fully charged and installed correctly.
- Check power cord, outlets, and propane system.
- Test safety detectors.
- Inspect leveling jacks (if equipped).

- Test all exterior and interior lights.
- Wash the exterior of the RV and inspect sealants.
- De-winterize and sanitize the fresh water system.
- Connect tow vehicle to RV and test all connections and lights.
- Test brakes.

Before Leaving The Campsite

- Check for water or fluid leaks under the RV.
- Turn off propane tanks.
- Empty and rinse black and gray holding tanks (if equipped) and store sewer hose.
- Retract and secure awning (if equipped).
- Close roof vents, windows, and blinds.
- Disconnect cable TV or phone hookup and lower TV antenna (if equipped).
- Turn off interior lights, water heater, water pump, furnace, and appliances.
- Snap the range hood vent closed (if equipped).
- Secure loose objects inside and outside the RV.
- Disconnect power cord and water connections.
- Store personal items and secure doors and cabinets.
- Retract slideouts (if equipped).
- Walk around RV to ensure everything is stored away and compartments are closed and locked.
- Retract leveling jacks and step (if equipped).
- Secure and lock entrance door.
- Clean up campsite and collect trash or debris.
- Ensure everyone, including pets and children, is accounted for.

CHECKLISTS

RV STORAGE CHECKLIST

⚠ CAUTION ⚠ (See page 104)

Properly preparing your RV for storage during periods of non-usage will prevent problems from arising. To prevent costly freeze-ups, winterize the plumbing system when it will not be in use for an extended period of time, especially if it is stored in colder climates.

Prior to Storage

- Store indoors, under a roof, or a breathable cover.
- Cover tires exposed to sunlight to prevent weather checking and UV damage.
- Wash interior and exterior thoroughly.
- Lubricate stabilizing jacks with WD40 or white lithium grease and raise for storage.
- Inspect roof and surfaces for damage and potential leaks.
- Seal off entry points for rodents, birds, or insects. Cover external outlets.
- Close all windows and roof vents.
- Cover roof air conditioner if equipped.
- Close propane cylinder valve(s) and cover regulator. Light a range gas burner to consume remaining gas in lines.
- Drain all water lines and ensure the RV is winterized.
- Drain and flush all holding tanks.
- Add fuel stabilizer to generator to prevent condensation and fuel varnishing.
- Disconnect 120-volt AC power.
- Remove all batteries and store in a non-freezing location.
- Turn cushions on edge to prevent moisture buildup.
- Turn off refrigerator and clean. Block doors open or use newspaper/baking soda to eliminate odors.
- Remove perishables from cabinets and leave doors ajar for air circulation.
- Lubricate locks and hinges on exterior doors.

During Storage Period

Remove snow from the top of the RV to prevent structural damage.

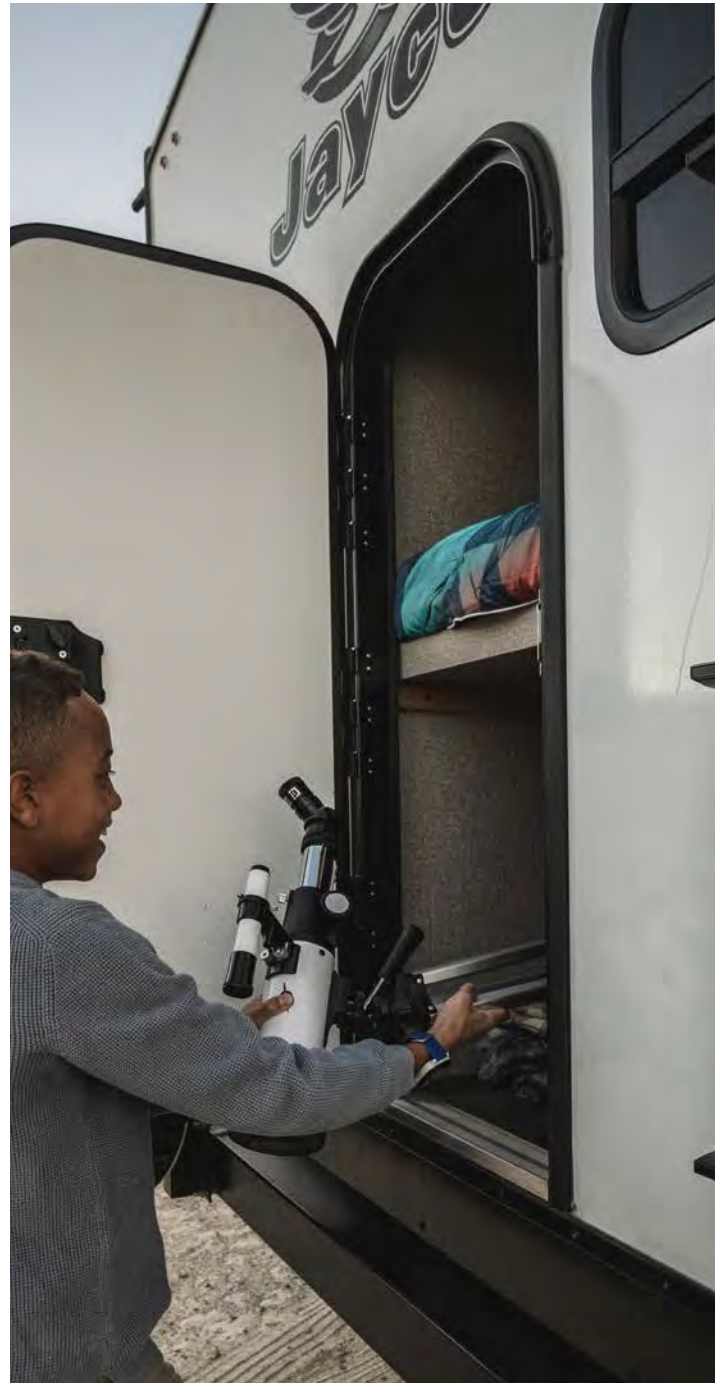

EXTERIOR CAUTION

RV STORAGE (See page 104)

Excessive snow, 8" or more, or ice, 2" or more, places excessive weight on the RV roof. Remove excessive snow or ice as needed. Care **MUST** be taken to not damage the roof material when removing snow & ice. Excessive weight can damage the roof, seals, etc. Water leaks and poor fit or operation are the results of this damage.

SECTION 15: ADDITIONAL INFORMATION



FEATURED COMPONENTS QUICK REFERENCE CHART

Your RV may be equipped with some of the items listed below. This is a partial listing and it is not intended to cover all components. All information is the latest available at the time of publication. Jayco reserves the right to change any of the following information without notice.

COMPONENT	MANUFACTURER	WEBSITE
Air Conditioner	Dometic Furrion GE Coleman-Mack	Dometic.com Furrion.com GEAppliances.com AirXCEL.com
Awning	LCI - Lippert Dometic Carefree	rvtechbridge.lippert.com Dometic.com CarefreeColorado.com
Axle	Dexter Axle LCI - Lippert	DexterAxle.com rvtechbridge.lippert.com
Entrance Step	Elkhart Tool & Die LCI - Lippert Mor/Ryde	postledistributors.com rvtechbridge.lippert.com MorRyde.com
Fan	MaxxAir Ventline	MaxxAir.com DexterAxle.com
Furnace	Dometic Suburban	Dometic.com SuburbanRV.com
Monitor Panel	KiB Positron ATC BMPro	www.ATComp.com PositronCorp.com www.ATComp.com TeamBMPro.com
Propane Regulator	Fairview USA Marshall Excelsior Cavagna Group	FairviewFittings.com MarshallExcelsior.com CavagnaGroup.com
Range/ Stove/ Cooktop	Insignia DDR Furrion Greystone Suburban	www.InsigniaProducts.com Call: 574-622-0402 Furrion.com Furrion.com SuburbanRV.com

COMPONENT	MANUFACTURER	WEBSITE
Range Hood	Furrion Ventline Heng's	Furrion.com DexterAxle.com Hengslndustries.com
Refrigerator	Dellcool Dometic Furrion Norcold RVision Everchill Whirlpool LG GE	Dellcool.com Dometic.com Furrion.com Norcold.com RVisionIntl.com Furrion.com Whirlpool.com LG.com GEAppliances.com
Thermostat	Dometic Furrion Suburban Coleman-Mack Truma	Dometic.com Furrion.com SuburbanRV.com AirXCEL.com Truma.net
TV Antenna	Winegard	Winegard.com
Water Heater	Dometic Suburban	Dometic.com SuburbanRV.com
Water Heater Tankless	Furrion Suburban Truma	Furrion.com SuburbanRV.com Truma.net
Water Pump	Seaflor Shurflo	SeaflorUSA.com Pentair.com

For information on other items including DVD/CD Player, Fire Extinguisher, Microwave, Propane/Carbon Monoxide Alarm, Smoke Alarm, TV, etc., see the manufacturer's user guide. Contact Customer Service for additional help.

ADDITIONAL INFORMATION

HELPFUL LINKS

Disclaimer: These links are being provided as a convenience and for informational purposes only; they do not constitute an endorsement by Jayco Inc. or any of its subsidiaries regarding any of the products, services, or opinions contained within. Jayco Inc. bears no responsibility for the accuracy, legality or content of the external site or for that of subsequent links. Contact the external site for answers to questions regarding its content.

NEWS & STORIES

Go RVing

gorving.com



The Go RVing program is the consumer-facing voice of the RV industry with a mission to inspire potential RVers, spark curiosity, and raise awareness about the benefits and accessibility of RVing through rich, authentic, and diverse storytelling.

TRAVEL RESOURCES

Bring Fido

bringfido.com



Explore over 500,000 places to stay, play, and eat with your dog.

U.S. Dept. of Transportation

fhwa.dot.gov/trafficinfo/index.htm

Federal Highway Administration's National Traffic and Road Closure Information



National Weather Service

weather.gov/alerts

National Weather Service Weather Alerts



Roadtrippers

roadtrippers.com



Plan your next road trip route with Roadtrippers. Enter where you want to start and finish your road trip, and then discover the coolest "off the beaten path" places along the way.

Included in "Roadpass Pro".

Sanidumps

sanidumps.com

Sanidumps is a comprehensive RV dump station search site.



Togo RV

togorv.com



Features and benefits include RV-specific GPS navigation, high-value member discounts, access to free boondocking locations, service and maintenance schedule tracking, customizable checklists, RV Living stories, and a mobile repair locator.

Included in "Roadpass Pro".



CLUBS & ORGANIZATIONS

FMCA

fmca.com

The FMCA educates, equips, and empowers RV owners in their journey to creating, experiencing, and benefiting from the outdoor lifestyle they dream of and deserve. All motorized and towable RVs welcome.



Your RVing Family

Good Sam Club

goodsam.com

Part of the RV community since 1966, Good Sam was founded on the idea of being good, doing good, and helping others. With over 2 million Good Sam Members and over 2100 Good Sam Parks and campgrounds, Good Sam makes it easy to travel and connect. Good Sam also offers a full suite of protection products including insurance, roadside assistance, extended service plans, and more.



Harvest Hosts

harvesthosts.com

Harvest Hosts is an RV membership program that provides unlimited overnight stays at thousands of locations nationwide such as farms, breweries, wineries, and much more. New members save 20% off of their first year of membership with the code JAYCO20.



Passport America

passportamerica.com

Passport America is a discount membership club that provides half price camping to a network of Over 1,200+ quality campgrounds and RV parks throughout the U.S., Canada and Mexico.



ADDITIONAL INFORMATION

CAMPSITE LOCATORS

Go Camping America

gocampingamerica.com

Whether you're planning the cross-country trip of a lifetime or just a weekend getaway, GoCampingAmerica.com is the best way to find the perfect home away from home for your next adventure.



AllStays

allstays.com

AllStays has comprehensive lists, maps, apps, and search tools for over 37,000 campsites.



National Park Service - Find a Park

nps.gov/findapark

The National Park Service website is a great resource for information on the national parks across the country. From there you can find a park, research events, and discover trip ideas.



Campendium

campendium.com

Campendium lists tens of thousands of places to camp, vetted by their team, and reviewed by over 750,000+ members.

Included in "Roadpass Pro".



RV Life Campground Reviews

campgrounds.rvlife.com

RV Life Campground Reviews will help you find a campground with easy to use maps and visitor reviews.



USCampgrounds.info

uscampgrounds.info

Web listing of over 13,000 public campgrounds in the US and Canada that are vehicle-accessible, family campgrounds with 4 or more campsites.



OTHER INFORMATION

Neighbor

neighbor.com/rv-storage-near-me



Get out and use your RV more, store it with a neighbor. Find a spot on Neighbor.com—the world's largest RV storage & self-storage marketplace. Find space in your neighborhood today, it's closer, safer, and cheaper than traditional RV storage. Neighbor.com, like it never left home.

RVIA

rvia.org

RV Industry Association is the leading trade voice of the RV industry, representing approximately 495 manufacturers and component and aftermarket suppliers who together produce 98 percent of all RVs made in the United States, and approximately 60 percent of RVs produced worldwide.



Roadpass Pro

roadpass.com/pro



Purchasing a new Jayco Family RV makes you eligible for one FREE year of Roadpass Pro, which includes bonus features to the apps "Campendium", "Roadtrippers", and "Togo RV".

Visit roadpass.com/first to sign up.

Current owners can receive a 30% discount on Roadpass Pro using the discount code below for your RV.

- Jayco Family: JAYCOFAMILY68

